

8100 Series VABGA Sockets

- Open top, Vertically Actuated Ball Grid Array
- Accommodates 1.0mm pitch package
- Proven, low force, high pressure “spoon” contacts
- Contacts are independent of one another
- Two points of contact per solder ball
- Molded in knock off feature
- Threaded stud mounting

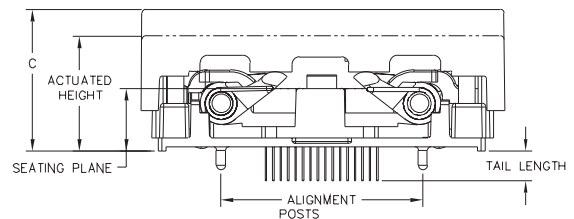

DESCRIPTION & ORDERING INFORMATION

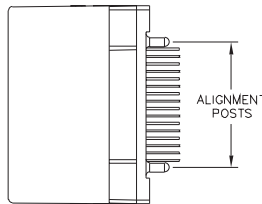
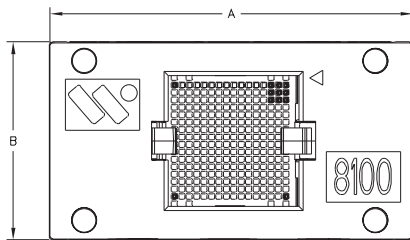
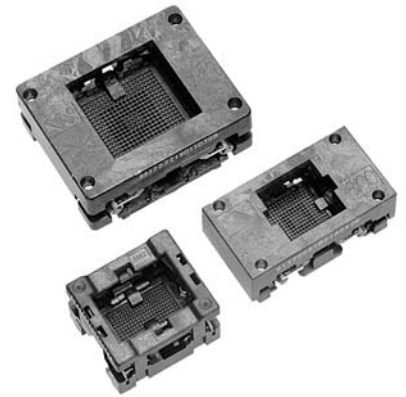
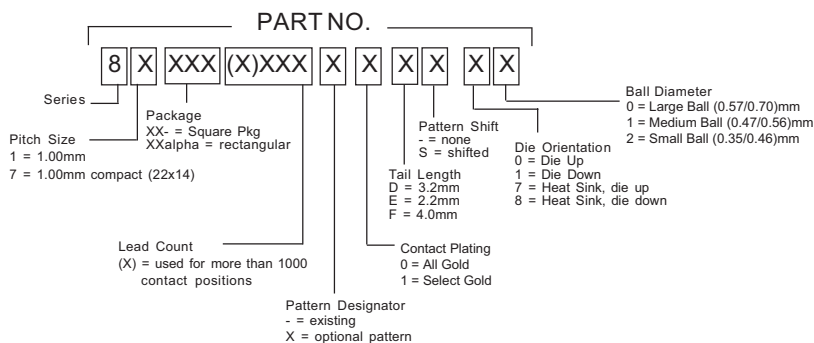

MATERIALS & SPECIFICATIONS

- Socket Body: PEI, LCP, or Equivalent
- Contact: Beryllium Copper Alloy
- Contact Plating: Gold over Nickel
- Contact Normal Force: 22 grams
- Contact Resistance: 100 mΩ max.
- Dielectric: 1000 V AC for 1 minute
- Temperature Rating: 125°C (Au)
- Insulation Resistance: 1000 MΩ @ 500V DC
- Durability: 10,000 cycles min.



8100 Series - 1.00mm Pitch Vertically Actuated BGA

Pitch e (mm)	Lead Count	Package Size	Matrix	Ball Dia. (mm)	Part Number	Socket Dimensions (mm)		
						Length (A)	Width (B)	Height (C)
1.00	36	6 X 6	6 X 6	0.40-0.70	8106-036-1E-OX	49.0	26.7	19.1
	64	9 X 9	8 X 8	0.40-0.70	8109-064-1E-OX	49.0	26.7	19.1
	74	12 X 12	10 X 10	0.40-0.70	8112-074-1ES0X	49.0	26.7	19.1
	80	11 X 11	10 X 10	0.40-0.70	8111-080-1E-OX	49.0	26.7	19.1
	81	10 X 10	9 X 9	0.40-0.70	8110-08-1ES0X	49.0	26.7	19.1
	96	15 X 15	14 X 14	0.40-0.70	8115-096-1E-OX	49.0	26.7	19.1
	100	11 X 11	10 X 10	0.40-0.70	8111-100-1E-OX	49.0	26.7	19.1
	106	13 X 13	12 X 12	0.40-0.70	8113-106-1E-OX	49.0	26.7	19.1
	120	15 X 15	14 X 14	0.40-0.70	8115-120-1E-OX	49.0	26.7	19.1
	136	19 X 19	14 X 14	0.40-0.70	8119-136-1E-OX	54.0	44.0	20.5
	144	13 X 13	12 X 12	0.40-0.70	8113-144-1E-OX	49.0	26.7	19.1
	148	15 X 15	14 X 14	0.40-0.70	8115-148-1E-OX	49.0	26.7	19.1
	156	15 X 15	14 X 14	0.40-0.70	8115-156-1E-OX	49.0	26.7	19.1
	160	15 X 15	14 X 14	0.40-0.70	8115-160X1E-OX	49.0	26.7	19.1
	172	15 X 15	14 X 14	0.40-0.70	8115-172-1E-OX	49.0	26.7	19.1
	176	15 X 15	14 X 14	0.40-0.70	8115-176-1E-OX	49.0	26.7	19.1
	184	19 X 19	17 X 17	0.40-0.70	8119-184-1ES0X	54.0	44.0	20.5
	192	17 X 17	16 X 16	0.40-0.70	8117-192-1E-OX	49.0	26.7	19.1
	196	15 X 15	14 X 14	0.40-0.70	8115-196-1E-OX	49.0	26.7	19.1
	196	17 X 17	14 X 14	0.40-0.70	8117-196-1E-OX	49.0	26.7	19.1
	208	15 X 15	14 X 14	0.40-0.70	8115-208-1E-OX	49.0	26.7	19.1
	208	17 X 17	16 X 16	0.40-0.70	8117-208X1E-OX	49.0	26.7	19.1
	220	21 X 21	20 X 20	0.40-0.70	8121-220-1E-OX	54.0	44.0	20.5
	225	19 X 19	18 X 18	0.40-0.70	8119-225-1E-OX	54.0	44.0	20.5
	239	19 X 19	18 X 18	0.40-0.70	8119-239-1E-OX	54.0	44.0	20.5
	240	19 X 19	18 X 18	0.40-0.70	8119-240-1E-OX	54.0	44.0	20.5
	256	17 X 17	16 X 16	0.40-0.70	8117-256-1E-OX	49.0	26.7	19.1
	256	21 X 21	20 X 20	0.40-0.70	8121-256-1E-OX	54.0	44.0	20.5
	272	21 X 21	20 X 20	0.40-0.70	8121-272-1E-OX	54.0	44.0	20.5
	280	20 X 20	18 X 18	0.40-0.70	8120-280-1E-OX	54.0	44.0	20.5
	288	19 X 19	18 X 18	0.40-0.70	8119-288X1E-OX	54.0	44.0	20.5
	288	23 X 23	22 X 22	0.40-0.70	8123-288-1E-OX	54.0	44.0	20.5
	289	19 X 19	18 X 18	0.40-0.70	8119-289-1ES0X	54.0	44.0	20.5
	300	21 X 21	20 X 20	0.40-0.70	8121-300X1E-OX	54.0	44.0	20.5
	304	23 X 23	22 X 22	0.40-0.70	8123-304-1E-OX	54.0	44.0	20.5
	320	25 X 25	24 X 24	0.40-0.70	8125-320-1E-OX	54.0	44.0	20.5
	321	23 X 23	21 X 21	0.40-0.70	8123-321X1ES0X	54.0	44.0	20.5
	324	19 X 19	18 X 18	0.40-0.70	8119-324-1E-OX	54.0	44.0	20.5
	324	23 X 23	22 X 22	0.40-0.70	8123-324-1E-OX	54.0	44.0	20.5
	340	23 X 23	22 X 22	0.40-0.70	8123-340-1E-OX	54.0	44.0	20.5
	342	23 X 23	22 X 22	0.40-0.70	8123-342-1E-OX	54.0	44.0	20.5
	352	27 X 27	26 X 26	0.40-0.70	8127-352-1E-OX	54.0	44.0	20.5
354	21 X 21	20 X 20	0.40-0.70	8121-354X1E-OX	54.0	44.0	20.5	
360	23 X 23	22 X 22	0.40-0.70	8123-360-1E-OX	54.0	44.0	20.5	
388	23 X 23	22 X 22	0.40-0.70	8123-388-1E-OX	54.0	44.0	20.5	
388	27 X 27	26 X 26	0.40-0.70	8127-388-1E-OX	54.0	44.0	20.5	
400	21 X 21	20 X 20	0.40-0.70	8121-400-1E-OX	54.0	44.0	20.5	
416	27 X 27	26 X 26	0.40-0.70	8127-416X1E-OX	54.0	44.0	20.5	
452	27 X 27	26 X 26	0.40-0.70	8127-452-1E-OX	54.0	44.0	20.5	
456	23 X 23	22 X 22	0.40-0.70	8123-456-1E-OX	54.0	44.0	20.5	
480	27 X 27	26 X 26	0.40-0.70	8127-480-1E-OX	54.0	44.0	20.5	
484	23 X 23	22 X 22	0.40-0.70	8123-484-1E-OX	54.0	44.0	20.5	
484	27 X 27	26 X 26	0.40-0.70	8127-484-1E-OX	54.0	44.0	20.5	
492	27 X 27	26 X 26	0.40-0.70	8127-492-1E-OX	54.0	44.0	20.5	
576	25 X 25	24 X 24	0.40-0.70	8125-576-1E-OX	54.0	44.0	20.5	
672	27 X 27	26 X 26	0.40-0.70	8127-672-1E-OX	54.0	44.0	20.5	
676	27 X 27	26 X 26	0.40-0.70	8127-676-1E-OX	54.0	44.0	20.5	
Rectangular Packages	40	11.5 X 15.5	10 X 4	0.40-0.70	8115A040-1DS0X	49.0	26.7	19.1
	48	12 X 10	8 X 6	0.40-0.70	8112A048-1E-OX	49.0	26.7	19.1
	48	14 X 10	8 X 6	0.40-0.70	8114A048-1D-OX	49.0	26.7	19.1
	64	13 X 10	8 X 8	0.40-0.70	8113A064-1E-OX	49.0	26.7	19.1
	64	13 X 11	8 X 8	0.40-0.70	8113B064A1E-OX	49.0	26.7	19.1
	80	12 X 10	10 X 8	0.40-0.70	8112A080-1E-OX	49.0	26.7	19.1
	80	13 X 10	10 X 8	0.40-0.70	8113A080-1E-OX	49.0	26.7	19.1
	209	22 X 14	19 X 11	0.40-0.70	8722A209-1E-OX	33.0	29.0	19.5

654 Series Ball Grid Array Socket

- Clamshell design with patented “Y” contact
- Two points of contact with lead scrub
- Pivoting pressure pad for uniform pressure
- Modular design allows for easy customization
- Spring loaded ejection

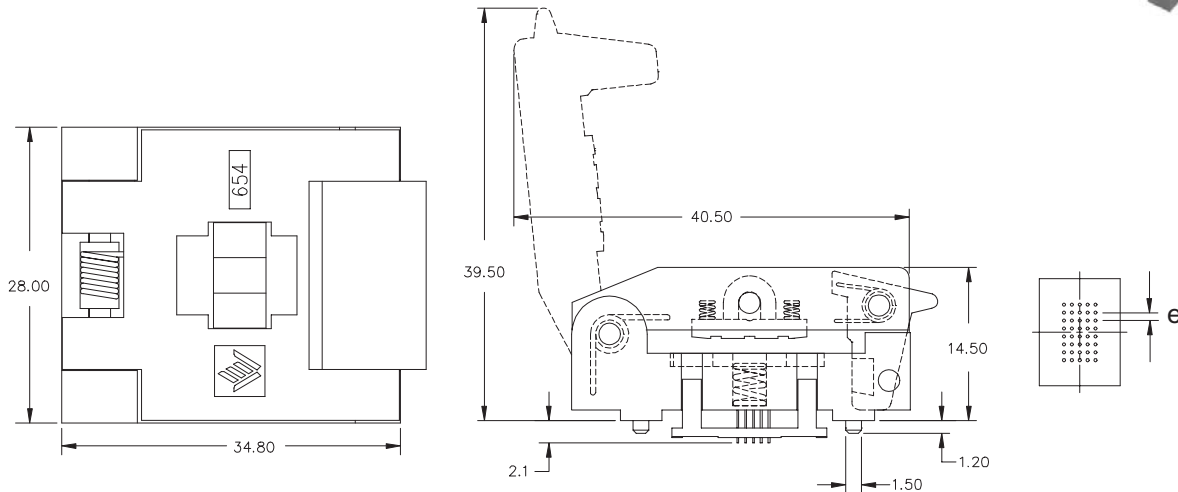

Pitch e (mm)	Lead Count	Package Size (mm)	Matrix	Ball Dia. (mm)	Ball Height (mm)	Part Number
1.00	48	10X11	6X8	0.45	0.30	654048228010812
	48	10X14	6X8	0.45	0.30	654048231010812
	48	10X14	6X8	0.45	0.30	654048228010828
	48	10X12	6X8	0.45	0.30	654048229010812
	48	10X12	6X8	0.40	0.30	654048228010813
	48	10X13	6X8	0.45	0.30	654048230010812
	72	9X13	6X12	0.50	0.32	654072228010820

DESCRIPTION & ORDERING INFORMATION

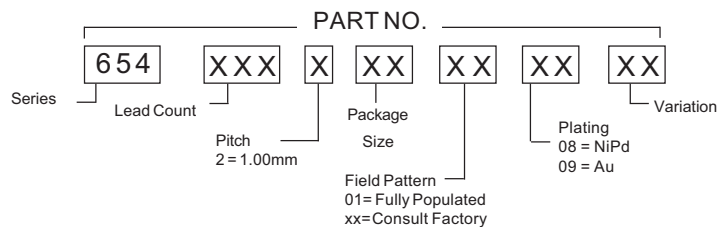

MATERIALS & SPECIFICATIONS

- Socket Body: PES, PEI, LCP or Equivalent
- Contact: Beryllium Copper Alloy
- Contact Plating: NiPd or Gold
- Contact Normal Force: 13 grams
- Contact Resistance: 100 mΩ max.
- Dielectric: 500V AC for 1 minute
- Temperature Rating: 150°C
- Insulation Resistance: 1000 MΩ @ 500V DC
- Durability: 10,000 cycles min.

1000-1 Series 0.80mm Pitch FBGA

- Open top, vertically actuated
- Pinch and scrub contact system
- Dual moving beams per contact
- Two points of contact per solder ball
- Board mounting features
- Through hole contact
- Maintains package position for ease of handler programming

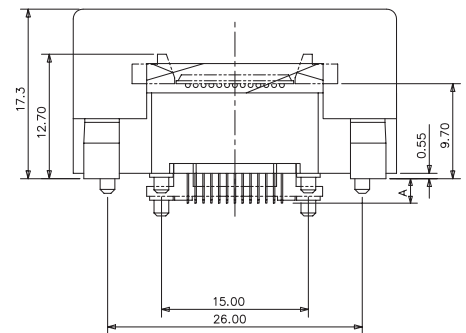
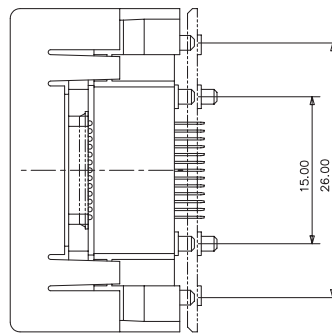
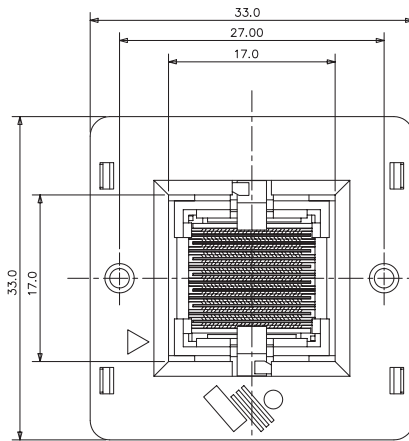
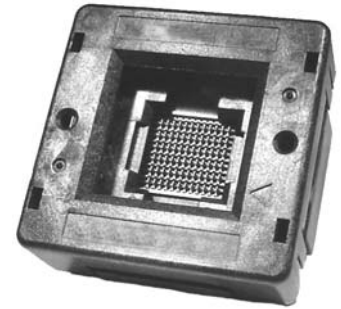

DESCRIPTION & ORDERING INFORMATION

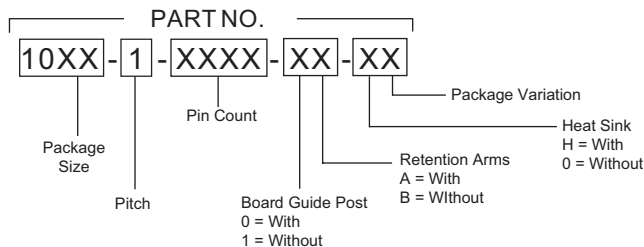

*Available contact tail lengths: 2.5mm (standard), 1.0mm, 2.0mm, 2.2mm, 3.0mm

MATERIALS & SPECIFICATIONS

- Socket Body and Lid: PES and LCP
- Contact: BeCu, Gold over Nickel Plated
- Metal Components: Stainless Steel
- Contact Force: 12 grams for 0.4mm dia. solder ball; 15g for 0.5mm dia. solder ball
- Actuation Force: 3 Kg, 5Kg, 7Kg for full grid depending on socket size
- Contact Resistance: < 50 mΩ
- Dielectric Withstanding Voltage: 500V RMS
- Current Carrying Capability: 0.5A
- Insulation Resistance: > 700 mΩ at 500V DC
- Temperature Rating: -55°C to +150°C
- Durability: 10,000 cycles (1 cycle - 1 load and 1 unload)



1000-1 Series 0.80mm Pitch FBGA

Pitch e (mm)	Lead Count	Package Size	Matrix	Ball Dia. (mm)	Part Number	Socket Dimensions (mm)		
						Length (A)	Width (B)	Height (C)
0.80	25	5X5	5X5	0.5 +/- 0.05	1005-1-0025-0B-00	33.0	33.0	17.3
	32	7X7	7X7	0.5 +/- 0.05	1007-1-0032-0B-00	33.0	33.0	17.3
	36	5X5	6X6	0.56	1005-1-0036-0B-00	33.0	33.0	17.3
	48	9X8	8X6	0.3	1009-1-0048-0B-00	33.0	33.0	17.3
	48	10X8	8X6	0.3	1010-1-0048-0B-00	33.0	33.0	17.3
	48	7X7	8X6	0.3	1007-1-0048-0B-00	33.0	33.0	17.3
	48	6X8	6X8	.335 +/- .035	1008-1-0048-0B-00	33.0	33.0	17.3
	48	9X6	8X6	0.3 +/- 0.05	1009-1-0048-0B-01	33.0	33.0	17.3
	49	8.5X8.5	7X7	0.42 +/- 0.05	1008-1-0049-0A-10	33.0	33.0	17.3
	49	7X7	7X7	0.48	1007-1-0049-0B-00	33.0	33.0	17.3
	56	8X10	8X8	0.4	1010-1-0056-0B-00	33.0	33.0	17.3
	56	12X12	8X8	0.4	1012-1-0056-0B-00	33.0	33.0	17.3
	63	9X11	12X10	0.4 +/- 0.05	1011-1-0063-0A-00	33.0	33.0	17.3
	63	11X9	12X10	0.4 +/- 0.05	1011-1-0063-0A-01	33.0	33.0	17.3
	64	9X9	10X10	0.5	1009-1-0064-0B-00	33.0	33.0	17.3
	64	8X8	8X8	0.5	1008-1-0064-0B-00	33.0	33.0	17.3
	64	8X10	8X8	0.4	1010-1-0064-0B-00	33.0	33.0	17.3
	64	8X8	8X8	0.5	1008-1-0064-0B-01	33.0	33.0	17.3
	64	7X7	8X8	0.4 +/- 0.15	1007-1-0064-0B-00	33.0	33.0	17.3
	64	12X10	8X8	0.34	1012-1-0064-0B-00	33.0	33.0	17.3
	69	8X8	9X9	0.5 +/- 0.05	1008-1-0069-0B-00	33.0	33.0	17.3
	69	12X10	12X10	0.45 +/- 0.05	1012-1-0069-0B-00	33.0	33.0	17.3
	74	8X8	9X9	0.4 +/- 0.05	1008-1-0074-0B-00	33.0	33.0	17.3
	79	12X10	12X10	0.4	1012-1-0079-0B-00	33.0	33.0	17.3
	80	9X9	10X10	0.5 +/- 0.05	1009-1-0080-0A-00	33.0	33.0	17.3
	81	8X8	9X9	.48 +/- 0.05	1008-1-0081-0B-00	33.0	33.0	17.3
	81	9X9	9X9	0.4	1009-1-0081-0B-00	33.0	33.0	17.3
	81	9X9	9X9	0.33 +/- 0.05	1009-1-0081-0B-01	33.0	33.0	17.3
	81	9X9	9X9	0.46 +/- 0.05	1009-1-0081-0A-00	33.0	33.0	17.3
	100	9X9	10X10	0.48	1009-1-0100-1A-00	33.0	33.0	17.3
	100	9X9	10X10	0.48 +/- 0.05	1009-1-0100-0B-00	33.0	33.0	17.3
	100	10X10	12X12	0.45	1010-1-0100-0B-00	33.0	33.0	17.3
	100	11X11	11X11	0.45 - 0.55	1011-1-0100-0B-00	33.0	33.0	17.3
	100	10X10	10X10	0.46 +/- 0.05	1010-1-0100-0B-01	33.0	33.0	17.3
	100	10X10	10X10	0.46	1010-1-0100-0A-00	33.0	33.0	17.3
	108	10X10	12X12	0.50 +/- 0.05	1010-1-0108-0B-00	33.0	33.0	17.3
	109	11X11	12X12	0.5	1011-1-0109-0B-00	33.0	33.0	17.3
	113	9X9	11X11	0.5 +/- 0.05	1009-1-0113-0B-00	33.0	33.0	17.3
	120	11X9	12X10	0.4 +/- 0.05	1011-1-0120-0A-00	33.0	33.0	17.3
	121	9X9	11X11	0.46	1009-1-0121-0B-00	33.0	33.0	17.3
	121	10X10	11X11	0.40 +/- 0.05	1010-1-0121-0B-00	33.0	33.0	17.3
	121	10X10	11X11	0.4 +/- 0.05	1010-1-0121-0B-01	33.0	33.0	17.3
	121	10X10	11X11	0.4	1010-1-0121-0B-02	33.0	33.0	17.3
	121	10X10	11X11	0.4 +/- 0.05	1010-1-0121-0A-00	33.0	33.0	17.3
	127	11X11	13X13	0.4 +/- 0.05	1011-1-0127-0B-00	33.0	33.0	17.3
127	11X11	13X13	0.4 +/- 0.05	1011-1-0127-0B-01	33.0	33.0	17.3	
128	11X11	12X12	0.05 +/- 0.05	1011-1-0128-1B-00	33.0	33.0	17.3	
128	11X11	12X12	0.46	1011-1-0128-0B-00	33.0	33.0	17.3	
128	11X11	12X12	0.46	1011-1-0128-0A-00	33.0	33.0	17.3	
144	12X12	13X13	0.5	1012-1-0144-0B-00	33.0	33.0	17.3	
144	10X10	12X12	0.4	1010-1-0144-0B-00	33.0	33.0	17.3	
144	10X10	12X12	0.46	1010-1-0144-0B-01	33.0	33.0	17.3	
144	10X10	12X12	0.40 +/- 0.1	1010-1-0144-0A-00	33.0	33.0	17.3	
144	10X10	12X12	0.5 +/- 0.05	1010-1-0144-0B-02	33.0	33.0	17.3	
169	12X12	13X13	0.35 - 0.55	1012-1-0169-1B-00	33.0	33.0	17.3	

Continued on next page



1000-1 Series 0.80mm Pitch FBGA

Pitch e (mm)	Lead Count	Package Size	Matrix	Ball Dia. (mm)	Part Number	Socket Dimensions (mm)		
						Length (A)	Width (B)	Height (C)
0.80	63	16X12	18X12	0.4 +/- 0.05	1016-1-0063-0A-00	40.0	40.0	17.3
	123	14X14	16X16	0.46	1014-1-0123-0B-00	40.0	40.0	17.3
	132	12X12	14X14	0.5 +/- .05	1012-1-0132-0B-00	40.0	40.0	17.3
	160	12X12	14X14	0.48	1012-1-0160-0A-00	40.0	40.0	17.3
	160	12X12	14X14	0.46	1012-1-0160-0B-00	40.0	40.0	17.3
	160	12X12	14X14	0.5 +/- 0.1	1012-1-0160-0A-01	40.0	40.0	17.3
	160	12X12	14X14	0.4 +/- 0.05	1012-1-0160-0A-02	40.0	40.0	17.3
	160	13X13	13X13	0.5 +/- 0.05	1013-1-0160-0B-00	40.0	40.0	17.3
	160	13X9	16X10	0.4	1013-1-0160-0B-01	40.0	40.0	17.3
	160	13X9	16X10	0.4	1013-1-0160-0B-02	40.0	40.0	17.3
	163	15X15	18X18	0.45 +/- 0.05	1015-1-0163-0A-00	40.0	40.0	17.3
	165	14X14	11X15	0.4 +/- 0.05	1014-1-0165-0B-00	40.0	40.0	17.3
	168	12X12	14X14	0.4 +/- 0.05	1012-1-0168-0B-00	40.0	40.0	17.3
	176	15X15	17X17	0.45 - 0.55	1015-1-0176-0A-00	40.0	40.0	17.3
	176	15X15	17X17	0.5	1015-1-0176-0B-00	40.0	40.0	17.3
	176	13X13	15X15	0.5 +/- 0.05	1013-1-0176-0B-00	40.0	40.0	17.3
	176	13X13	15X15	0.46	1013-1-0176-0B-01	40.0	40.0	17.3
	176	13X13	15X15	0.46	1013-1-0176-0A-00	40.0	40.0	17.3
	179	12X12	14X14	0.30 - 0.50	1012-1-0179-0B-00	40.0	40.0	17.3
	180	12X12	14X14	0.5 +/- 0.05	1012-1-0180-0B-00	40.0	40.0	17.3
	180	12X12	14X14	0.48	1012-1-0180-0B-01	40.0	40.0	17.3
	185	13X13	15X15	0.46 +/- 0.1	1013-1-0185-0A-00	40.0	40.0	17.3
	192	14X14	16X16	0.46	1014-1-0192-0B-00	40.0	40.0	17.3
	192	14X14	16X16	0.46 +/- 0.05	1014-1-0192-0A-00	40.0	40.0	17.3
	192	13X13	14X14	0.5 +/- 0.05	1013-1-0192-0B-00	40.0	40.0	17.3
	192	11X13	12X16	0.4 +/- 0.05	1013-1-0192-0B-01	40.0	40.0	17.3
	192	11X13	12X16	0.4 +/- 0.05	1013-1-0192-0B-02	40.0	40.0	17.3
	196	12X12	14X14	0.5	1012-1-0196-0B-00	40.0	40.0	17.3
	200	13X13	15X15	0.4 +/- 0.05	1013-1-0200-0B-00	40.0	40.0	17.3
	208	15X15	17X17	0.46	1015-1-0208-0A-00	40.0	40.0	17.3
	208	15X15	17X17	0.45	1015-1-0208-0B-00	40.0	40.0	17.3
	208	15X15	17X17	0.46	1015-1-0208-0A-01	40.0	40.0	17.3
	208	15X15	17X17	0.5 +/- 0.15	1015-1-0208-0A-02	40.0	40.0	17.3
	209	16X16	19X19	0.45 - 0.55	1016-1-0209-0B-00	40.0	40.0	17.3
	216	16X12	18X12	0.4 +/- 0.05	1016-1-0216-0A-00	40.0	40.0	17.3
	217	15X15	17X17	0.4 +/- 0.05	1015-1-0217-0B-00	40.0	40.0	17.3
	224	13X13	15X15	0.35 - 0.45	1013-1-0224-0A-00	40.0	40.0	17.3
	225	15X15	15X15	0.35 - 0.45	1015-1-0225-0A-00	40.0	40.0	17.3
	225	13X13	15X15	0.35 - 0.45	1013-1-0225-0B-00	40.0	40.0	17.3
	225	13X13	15X15	0.35 - 0.45	1013-1-0225-0B-01	40.0	40.0	17.3
225	13X13	15X15	0.4 +/- 0.05	1013-1-0225-0A-00	40.0	40.0	17.3	
225	13X13	15X15	0.44	1013-1-0225-0B-02	40.0	40.0	17.3	
225	13X13	15X15	0.467	1013-1-0225-0A-01	40.0	40.0	17.3	
225	13X13	15X15	0.4 +/- 0.05	1013-1-0225-0A-02	40.0	40.0	17.3	
232	14X14	16X16	0.35 - 0.45	1014-1-0232-0A-00	40.0	40.0	17.3	
233	15X15	17X17	0.46 +/- 0.1	1015-1-0233-0A-00	40.0	40.0	17.3	
236	14X14	16X16	0.53	1014-1-0236-0B-00	40.0	40.0	17.3	
240	15X15	17X17	0.5	1015-1-0240-0B-00	40.0	40.0	17.3	
240	16X16	19X19	0.5 +/- 0.05	1016-1-0240-0A-00	40.0	40.0	17.3	
249	15X15	17X17	0.45 - 0.55	1015-1-0249-0B-00	40.0	40.0	17.3	
256	14X14	16X16	0.40 +/- 0.05	1014-1-0256-0A-00	40.0	40.0	17.3	
256	15X15	17X17	0.5 +/- 0.05	1015-1-0256-0B-00	40.0	40.0	17.3	
256	13X13	16X16	0.56	1013-1-0256-0B-00	40.0	40.0	17.3	
257	16X16	19X19	0.45 - 0.55	1016-1-0257-0B-00	40.0	40.0	17.3	
280	16X16	19X19	0.48	1016-1-0280-0B-00	40.0	40.0	17.3	
280	16X16	19X19	0.45 +/- 0.05	1016-1-0280-0A-00	40.0	40.0	17.3	

Continued on next page



1000-1 Series 0.80mm Pitch FBGA

Pitch e (mm)	Lead Count	Package Size	Matrix	Ball Dia. (mm)	Part Number	Socket Dimensions (mm)		
						Length (A)	Width (B)	Height (C)
0.80	280	17X17	19X19	0.45	1017-1-0280-0B-00	40.0	40.0	17.3
	285	16X16	18X18	0.5 +/- 0.05	1016-1-0285-0B-00	40.0	40.0	17.3
	285	16X16	18X18	0.5 +/- 0.05	1016-1-0285-0B-01	40.0	40.0	17.3
	285	16X16	18X18	0.5 +/- 0.05	1016-1-0285-0A-00	40.0	40.0	17.3
	288	16X16	19X19	0.45 - 0.55	1016-1-0288-0B-00	40.0	40.0	17.3
	288	16X16	19X19	0.5 +/- 0.05	1016-1-0288-0B-01	40.0	40.0	17.3
	289	15X15	17X17	0.48	1015-1-0289-0A-00	40.0	40.0	17.3
	291	16X16	19X19	0.4 +/- 0.05	1016-1-0291-0A-00	40.0	40.0	17.3
	312	16X16	19X19	0.45 - 0.55	1016-1-0312-0B-00	40.0	40.0	17.3
	332	17X17	19X19	0.5 +/- 0.1	1017-1-0332-0B-00	40.0	40.0	17.3
	332	17X17	19X19	0.40 - 0.60	1017-1-0332-0B-01	40.0	40.0	17.3
	332	17X17	19X19	0.40 - 0.60	1017-1-0332-0B-02	40.0	40.0	17.3
	332	17X17	19X19	0.5 +/- 0.1	1017-1-0332-0A-00	40.0	40.0	17.3
	332	17X17	19X19	0.5 +/- 0.1	1017-1-0332-1A-00	40.0	40.0	17.3
	332	17X17	19X19	0.5 +/- 0.1	1017-1-0332-0B-03	40.0	40.0	17.3
	332	17X17	19X19	0.5 +/- 0.1	1017-1-0332-0B-04	40.0	40.0	17.3
	361	16X16	19X19	0.45 - 0.55	1016-1-0361-0B-00	40.0	40.0	17.3
	361	17X17	19X19	0.5	1017-1-0361-0B-00	40.0	40.0	17.3
	256	17X17	20X20	0.45	1017-1-0256-0B-00	45.0	45.0	17.3
	272	17X17	20X20	0.45	1017-1-0272-0B-00	45.0	45.0	17.3
	272	17X17	20X20	0.46 +/- 0.05	1017-1-0272-0B-01	45.0	45.0	17.3
	272	17X17	20X20	0.4 +/- 0.05	1017-1-0272-0A-00	45.0	45.0	17.3
	288	19X19	22X22	0.46	1019-1-0288-0B-00	45.0	45.0	17.3
	316	17X17	20X20	0.46	1017-1-0316-0B-00	45.0	45.0	17.3
	320	18X18	21X21	0.4 +/- 0.05	1018-1-0320-0B-00	45.0	45.0	17.3
	324	19X19	22X22	0.45	1019-1-0324-0B-00	45.0	45.0	17.3
	352	18X18	22X22	0.4 +/- 0.05	1018-1-0352-0A-00	45.0	45.0	17.3
	360	17X17	20X20	0.5 +/- 0.05	1017-1-0360-0A-00	45.0	45.0	17.3
	360	19X19	23X23	0.46 +/- 0.1	1019-1-0360-0B-00	45.0	45.0	17.3
	384	18X18	22X22	0.50 +/- 0.1	1018-1-0384-0A-00	45.0	45.0	17.3
	384	18X18	22X22	0.50 +/- 0.1	1018-1-0384-0A-01	45.0	45.0	17.3
	384	18X18	22X22	0.50 +/- 0.1	1018-1-0384-0A-02	45.0	45.0	17.3
	399	17X17	20X20	0.4 +/- 0.05	1017-1-0399-0B-00	45.0	45.0	17.3
	399	17X17	20X20	0.4 +/- 0.05	1017-1-0399-0B-01	45.0	45.0	17.3
	400	17X17	20X20	0.4 +/- 0.05	1017-1-0400-0A-00	45.0	45.0	17.3
	400	17X17	20X20	0.4 +/- 0.05	1017-1-0400-0B-00	45.0	45.0	17.3
	400	17X17	20X20	0.4 +/- 0.05	1017-1-0400-0A-01	45.0	45.0	17.3
	424	19X19	23X23	0.4 +/- 0.05	1019-1-0424-0B-00	45.0	45.0	17.3
	424	19X19	23X23	0.4 +/- 0.05	1019-1-0424-0B-01	45.0	45.0	17.3
	424	19X19	23X23	0.4 +/- 0.05	1019-1-0424-0B-02	45.0	45.0	17.3
	431	20X20	21X21	0.5 +/- 0.05	1020-1-0431-0B-00	45.0	45.0	17.3
	431	20X20	21X21	0.5 +/- 0.05	1020-1-0431-0A-00	45.0	45.0	17.3
431	20X20	21X21	0.5 +/- 0.05	1020-1-0431-0A-01	45.0	45.0	17.3	
480	19X19	22X22	0.4 +/- 0.05	1019-1-0480-0B-00	45.0	45.0	17.3	
480	19X19	22X22	0.4 +/- 0.05	1019-1-0480-0B-01	45.0	45.0	17.3	
480	19X19	22X22	0.4 +/- 0.05	1019-1-0480-0A-00	45.0	45.0	17.3	
484	18X18	22X22	0.50 +/- 0.1	1018-1-0484-0A-00	45.0	45.0	17.3	
484	19X19	22X22	0.46	1019-1-0484-0B-00	45.0	45.0	17.3	
484	19X19	22X22	0.46	1019-1-0484-0A-00	45.0	45.0	17.3	
529	19X19	23X23	0.4 +/- 0.05	1019-1-0529-0B-00	45.0	45.0	17.3	
560	42.5X42.5	33X33	0.75	1042-1-0560-0B-10	45.0	45.0	17.3	

1000-2 Series 1.00mm Pitch FBGA

- Open top, vertically actuated
- Pinch and scrub contact system
- Dual moving beams per contact
- Two points of contact per solder ball
- Board mounting features
- Through hole contact
- Maintains package position for ease of handler programming

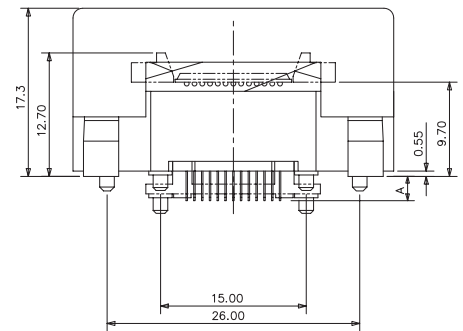
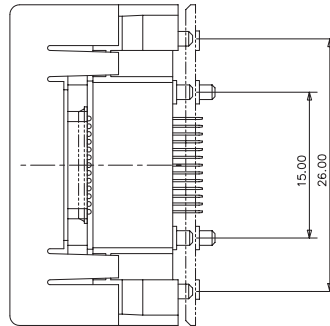
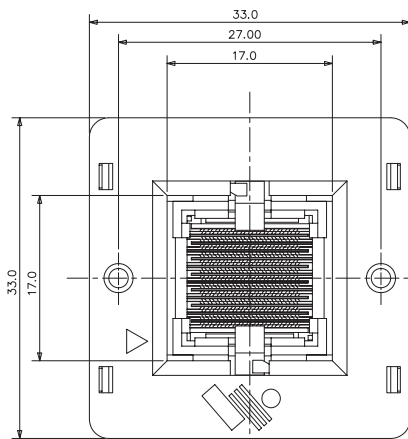
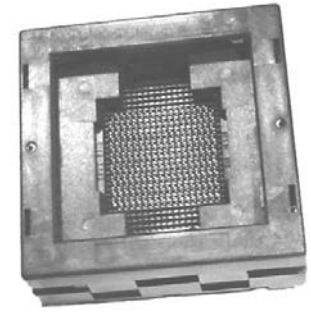

DESCRIPTION & ORDERING INFORMATION

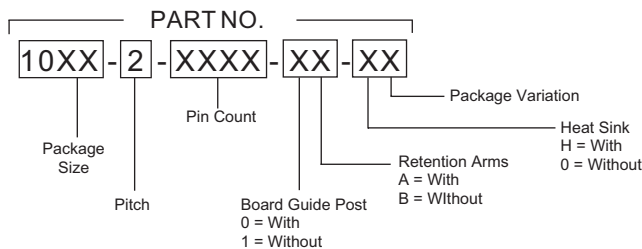

*Available contact tail lengths: 2.2mm, 2.8mm

MATERIALS & SPECIFICATIONS

- Socket Body and Lid: PES and LCP
- Contact: BeCu, Gold over Nickel Plated
- Metal Components: Stainless Steel
- Contact Force: 17 grams for 0.6mm dia. solder ball;
14g for 0.5mm dia. solder ball
- Actuation Force: 5Kg for full grid
- Contact Resistance: < 50 mΩ
- Dielectric Withstanding Voltage: 500V RMS
- Current Carrying Capability: 1.0A
- Insulation Resistance: > 1000 mΩ at 100V DC
- Temperature Rating: -55°C to +150°C
- Durability: 10,000 cycles (1 cycle - 1 load and 1 unload)



1000-2 Series 1.00mm Pitch FBGA

Pitch e (mm)	Lead Count	Package Size	Matrix	Ball Dia. (mm)	Part Number	Socket Dimensions (mm)		
						Length (A)	Width (B)	Height (C)
1.00	36	12X17	9X11	0.40 +/- 0.10	1017-2-0036-0B-00	33.0	33.0	16.5
	36	6X6	6X6	0.53	1006-2-0036-0B-00	33.0	33.0	16.5
	44	12X10	8X8	0.45 +/- 0.05	1012-2-0044-0B-00	33.0	33.0	16.5
	44	12X10	8X8	0.45 +/- 0.05	1012-2-0044-0A-00	33.0	33.0	16.5
	44	12X10	8X8	0.45 +/- 0.05	1012-2-0044-0A-01	33.0	33.0	16.5
	44	10X12	8X8	0.45	1012-2-0044-0B-01	33.0	33.0	16.5
	44	18X12	8X8	0.45 +/- 0.05	1018-2-0044-0B-00	33.0	33.0	16.5
	44	18X12	8X8	0.45 +/- 0.05	1018-2-0044-0B-01	33.0	33.0	16.5
	48	10X12	6X8	0.50 +/- 0.05	1012-2-0048-0B-00	33.0	33.0	16.5
	48	17.65X5	12X4	0.6 3 +/- 0.1	1017-2-0048-0B-10	33.0	33.0	16.5
	56	18X12	14X8	0.45 +/- 0.05	1018-2-0056-0A-00	33.0	33.0	16.5
	56	18X12	14X8	0.45 +/- 0.05	1018-2-0056-0B-00	33.0	33.0	16.5
	63	15X12	12X8	0.5 +/- 0.05	1015-2-0063-0B-00	33.0	33.0	16.5
	64	15X12	12X8	0.5 +/- 0.05	1015-2-0064-0B-00	33.0	33.0	16.5
	64	13X10	8X8	0.45 +/- 0.05	1013-2-0064-0B-00	33.0	33.0	16.5
	74	12X12	11X11	0.60 +/- 0.1	1012-2-0074-0B-00	33.0	33.0	16.5
	74	12X12	11X11	0.6	1012-2-0074-0B-01	33.0	33.0	16.5
	74	12X12	11X11	0.6	1012-2-0074-0B-02	33.0	33.0	16.5
	100	11X11	10X10	0.43	1011-2-0100-0B-00	33.0	33.0	16.5
	100	11X11	10X10	0.6	1011-2-0100-0B-01	33.0	33.0	16.5
	100	11X11	10X10	0.45 +/- 0.05	1011-2-0100-0B-02	33.0	33.0	16.5
	117	13X13	12X12	0.5 +/- 0.1	1013-2-0117-0B-00	33.0	33.0	16.5
	117	14X10	13X9	0.6 +/- 0.1	1014-2-0117-0B-00	33.0	33.0	16.5
	121	12X12	11X11	0.6 +/- 0.1	1012-2-0121-0B-00	33.0	33.0	16.5
	127	13X13	12X12	0.635 +/- 0.05	1013-2-0127-0B-00	33.0	33.0	16.5
	132	13X13	12X12	0.5 +/- 0.1	1013-2-0132-0B-00	33.0	33.0	16.5
	132	13X13	12X12	0.5 +/- 0.15	1013-2-0132-0B-01	33.0	33.0	16.5
	143	15X15	14X14	0.5	1015-2-0143-0B-00	33.0	33.0	16.5
	144	13X13	12X12	0.5 +/- 0.1	1013-2-0144-0B-00	33.0	33.0	16.5
	144	15X15	13X13	0.5 +/- 0.05	1015-2-0144-0B-00	33.0	33.0	16.5
	144	15X15	13X13	0.5 +/- 0.05	1015-2-0144-0A-00	33.0	33.0	16.5
	144	15X15	13X13	0.5 +/- 0.05	1015-2-0144-0A-01	33.0	33.0	16.5
	156	15X15	14X14	0.5 +/- 0.1	1015-2-0156-0A-00	33.0	33.0	16.5
	160	15X15	14X14	0.53	1015-2-0160-0B-00	33.0	33.0	16.5
	172	15X15	14X14	0.45	1015-2-0172-0B-00	33.0	33.0	16.5
	172	15X15	14X14	0.45	1015-2-0172-0A-00	33.0	33.0	16.5
	172	15X15	14X14	0.45	1015-2-0172-0A-01	33.0	33.0	16.5
	181	17X17	15X15	0.5 +/- 0.05	1017-2-0181-0B-00	33.0	33.0	16.5
	181	17X17	15X15	0.5 +/- 0.05	1017-2-0181-0B-01	33.0	33.0	16.5
	192	17X17	16X16	0.5 +/- 0.05	1017-2-0192-0B-00	33.0	33.0	16.5
	192	17X17	16X16	0.6	1017-2-0192-0B-01	33.0	33.0	16.5
	196	15X15	14X14	0.50 - 0.70	1015-2-0196-0B-00	33.0	33.0	16.5
	196	15X15	14X14	0.45 - 0.55	1015-2-0196-0B-01	33.0	33.0	16.5
	196	15X15	14X14	0.5 +/- 0.05	1015-2-0196-0A-00	33.0	33.0	16.5
	208	17X17	16X16	0.6 +/- 0.1	1017-2-0208-0B-00	33.0	33.0	16.5
208	17X17	16X16	0.6 +/- 0.1	1017-2-0208-0B-01	33.0	33.0	16.5	
208	17X17	16X16	0.6 +/- 0.1	1017-2-0208-0B-02	33.0	33.0	16.5	
224	17X15	16X14	0.5 +/- 0.1	1017-2-0224-0B-00	33.0	33.0	16.5	
228	17X17	16X16	0.6 +/- 0.1	1017-2-0228-0B-00	33.0	33.0	16.5	
228	17X17	16X16	0.5 +/- 0.1	1017-2-0228-0B-01	33.0	33.0	16.5	
244	17X17	16X16	0.6 +/- 0.1	1017-2-0244-0B-00	33.0	33.0	16.5	
252	17X17	16X16	0.5 +/- 0.1	1017-2-0252-0B-00	33.0	33.0	16.5	
252	17X17	16X16	0.5 +/- 0.1	1017-2-0252-0B-01	33.0	33.0	16.5	
255	17X17	16X16	0.6 +/- 0.1	1017-2-0255-0B-00	33.0	33.0	16.5	
256	17X17	16X16	0.40 - 0.60	1017-2-0256-0B-00	33.0	33.0	16.5	
256	17X17	16X16	0.6 +/- 0.1	1017-2-0256-0B-01	33.0	33.0	16.5	
256	17X17	16X16	0.45 +/- 0.1	1017-2-0256-0A-00	33.0	33.0	16.5	

Continued on next page



1000-2 Series 1.00mm Pitch FBGA

Pitch e (mm)	Lead Count	Package Size	Matrix	Ball Dia. (mm)	Part Number	Socket Dimensions (mm)		
						Length (A)	Width (B)	Height (C)
1.00	289	19X18	17X17	0.5	1019-2-0289-0B-00	33.0	33.0	16.5
	289	18X18	17X17	0.6 +/- 0.1	1018-2-0289-0B-00	33.0	33.0	16.5
	93	19X19	18X18	0.6 +/- 0.1	1019-2-0093-0B-00	45.0	45.0	16.5
	116	16X13	15X12	0.5 +/- 0.05	1016-2-0116-0B-00	45.0	45.0	16.5
	117	10X14	9X13	0.6	1014-2-0117-0B-00	45.0	45.0	16.5
	123	23X23	22X22	0.6 3+/- 0.1	1023-2-0123-0B-00	45.0	45.0	16.5
	144	10X10	12X12	0.5 +/- 0.05	1010-2-0144-0B-00	45.0	45.0	16.5
	159	19X19	18X18	0.65 +/- 0.01	1019-2-0159-0B-00	45.0	45.0	16.5
	181	17X17	15X15	0.5 +/- 0.05	1017-2-0181-0B-00	45.0	45.0	16.5
	196	23X23	22X22	0.6 +/- 0.05	1023-2-0196-0B-00	45.0	45.0	16.5
	197	27X27	26X26	0.6 +/- 0.1	1027-2-0197-0B-00	45.0	45.0	16.5
	209	22X14	19X11	0.6	1022-2-0209-0B-00	45.0	45.0	16.5
	209	17X23	11X19	0.6	1023-2-0209-0B-00	45.0	45.0	16.5
	239	19X19	18X18	0.6	1019-2-0239-0B-00	45.0	45.0	16.5
	256	19X19	18X18	0.5	1019-2-0256-0B-00	45.0	45.0	16.5
	256	17X17	16X16	0.40 - 0.60	1017-2-0256-0B-00	45.0	45.0	16.5
	259	19X19	18X18	0.457	1019-2-0259-0B-00	45.0	45.0	16.5
	260	19X19	18X18	0.5 +/- 0.05	1019-2-0260-0B-00	45.0	45.0	16.5
	260	19X19	18X18	0.53 +/- 0.15	1019-2-0260-0B-01	45.0	45.0	16.5
	270	19X19	17X17	0.5	1019-2-0270-0B-00	45.0	45.0	16.5
	270	27X27	26X26	0.6 +/- 0.1	1027-2-0270-0B-00	45.0	45.0	16.5
	276	19X19	18X18	0.6 +/- 0.1	1019-2-0276-0B-00	45.0	45.0	16.5
	276	27X27	26X26	0.50 - 0.70	1027-2-0276-0B-00	45.0	45.0	16.5
	276	27X27	26X26	0.50 - 0.70	1027-2-0276-0B-01	45.0	45.0	16.5
	288	19X19	18X18	0.43	1019-2-0288-1B-00	45.0	45.0	16.5
	288	19X19	18X18	0.43	1019-2-0288-0B-00	45.0	45.0	16.5
	288	23X23	22X22	0.50 - 0.70	1023-2-0288-0B-00	45.0	45.0	16.5
	289	19X19	17X17	0.5	1019-2-0289-0B-00	45.0	45.0	16.5
	305	19X19	18X18	0.5 +/- 0.1	1019-2-0305-0B-00	45.0	45.0	16.5
	305	19X19	18X18	0.5 +/- 0.1	1019-2-0305-0A-00	45.0	45.0	16.5
	305	19X19	18X18	0.5 +/- 0.1	1019-2-0305-0B-01	45.0	45.0	16.5
	316	21X21	20X20	0.46 +/- 0.05	1021-2-0316-0A-00	45.0	45.0	16.5
	321	19X19	18X18	0.6 +/- 0.05	1019-2-0321-0B-00	45.0	45.0	16.5
	324	19X19	18X18	0.50 +/- 0.05	1019-2-0324-0B-00	45.0	45.0	16.5
	324	19X19	18X18	0.6	1019-2-0324-0B-01	45.0	45.0	16.5
	324	19X19	18X18	0.6	1019-2-0324-0B-02	45.0	45.0	16.5
	324	23X23	22X22	0.49 - 0.51	1023-2-0324-0B-00	45.0	45.0	16.5
	324	23X23	22X22	0.6 +/- 0.1	1023-2-0324-0B-01	45.0	45.0	16.5
	352	27X27	26X26	0.6	1027-2-0352-0B-00	45.0	45.0	16.5
	352	27X27	26X26	0.6	1027-2-0352-0A-00	45.0	45.0	16.5
	352	27X27	26X26	0.60 +/- 0.1	1027-2-0352-0B-01	45.0	45.0	16.5
354	21X21	20X20	0.6	1021-2-0354-0B-00	45.0	45.0	16.5	
361	21X21	19X19	0.5	1021-2-0361-0B-00	45.0	45.0	16.5	
364	21X21	20X20	0.5 +/- 0.1	1021-2-0364-0B-00	45.0	45.0	16.5	
364	21X21	20X20	0.6 +/- 0.1	1021-2-0364-0B-01	45.0	45.0	16.5	
376	23X23	22X22	0.6 +/- 0.1	1023-2-0376-0B-00	45.0	45.0	16.5	
380	25X25	24X24	0.60 - 0.65	1025-2-0380-0B-00	45.0	45.0	16.5	
388	27X27	26X26	0.50 - 0.70	1027-2-0388-0B-00	45.0	45.0	16.5	
388	27X27	26X26	0.50 - 0.70	1027-2-0388-1B-00	45.0	45.0	16.5	
388	27X27	26X26	0.50 - 0.70	1027-2-0388-0B-01	45.0	45.0	16.5	
388	27X27	26X26	0.6	1027-2-0388-0B-02	45.0	45.0	16.5	
396	23X23	22X22	0.6 +/- 0.1	1023-2-0396-0B-00	45.0	45.0	16.5	
399	21X21	20X20	.06 +/- 0.1	1021-2-0399-0B-00	45.0	45.0	16.5	
416	27X27	26X26	0.58 - 0.64	1027-2-0416-0B-00	45.0	45.0	16.5	

Continued on next page



1000-2 Series 1.00mm Pitch FBGA

Pitch e (mm)	Lead Count	Package Size	Matrix	Ball Dia. (mm)	Part Number	Socket Dimensions (mm)		
						Length (A)	Width (B)	Height (C)
1.00	420	23X23	22X22	0.6 +/- 0.1	1023-2-0420-0B-00	45.0	45.0	16.5
	448	23X23	22X22	0.63 +/- 0.1	1023-2-0448-0B-00	45.0	45.0	16.5
	452	27X27	26X26	0.63	1027-2-0452-0A-00	45.0	45.0	16.5
	456	23X23	22X22	0.6 +/- 0.1	1023-2-0456-1B-00	45.0	45.0	16.5
	456	23X23	22X22	0.6 +/- 0.1	1023-2-0456-0B-00	45.0	45.0	16.5
	456	23X23	22X22	0.50 - 0.70	1023-2-0456-0B-01	45.0	45.0	16.5
	481	27X27	26X26	0.6 +/- 0.1	1027-2-0481-0B-00	45.0	45.0	16.5
	484	23X23	22X22	0.50 +/- 0.15	1023-2-0484-0B-00	45.0	45.0	16.5
	484	23X23	22X22	0.6	1023-2-0484-0B-01	45.0	45.0	16.5
	484	23X23	22X22	0.45 +/- 0.05	1023-2-0484-0A-00	45.0	45.0	16.5
	484	23X23	22X22	0.6 +/- 0.1	1023-2-0484-0A-01	45.0	45.0	16.5
	484	23X23	22X22	0.45 +/- 0.05	1023-2-0484-0A-02	45.0	45.0	16.5
	484	27X27	26X26	0.6	1027-2-0484-0B-00	45.0	45.0	16.5
	516	27X27	26X26	0.6 +/- 0.1	1027-2-0516-0B-00	45.0	45.0	16.5
	544	27X27	26X26	0.6 +/- 0.1	1027-2-0544-0B-00	45.0	45.0	16.5
	672	27X27	26X26	0.6 +/- 0.1	1027-2-0672-0B-00	45.0	45.0	16.5
	672	27X27	26X26	0.6	1027-2-0672-1B-00	45.0	45.0	16.5
	672	27X27	26X26	0.5	1027-2-0672-0B-01	45.0	45.0	16.5
	675	27X27	26X26	0.6 +/- 0.1	1027-2-0675-0B-00	45.0	45.0	16.5
	675	27X27	26X26	0.50 - 0.70	1027-2-0675-0B-01	45.0	45.0	16.5
	676	27X27	26X26	0.6 +/- 0.1	1027-2-0676-1B-00	45.0	45.0	16.5
	676	27X27	26X26	0.6 +/- 0.1	1027-2-0676-0B-00	45.0	45.0	16.5
	676	27X27	26X26	0.5	1027-2-0676-0B-01	45.0	45.0	16.5
	676	27X27	26X26	0.6	1027-2-0676-0B-02	45.0	45.0	16.5
	676	27X27	26X26	0.6 +/- 0.1	1027-2-0676-0B-03	45.0	45.0	16.5
	676	27X27	26X26	0.6 +/- 0.1	1027-2-0676-0A-00	45.0	45.0	16.5
	434	35X35	34X34	0.6 +/- 0.1	1035-2-0434-0B-00	62.0	62.0	24.0
	500	31X31	30X30	0.6 +/- 0.1	1031-2-0500-0B-00	62.0	62.0	24.0
	680	35X35	34X34	0.6 +/- 0.1	1035-2-0680-0B-00	62.0	62.0	24.0
	751	35X35	34X34	0.6 +/- 0.1	1035-2-0751-0B-00	62.0	62.0	24.0
	772	35X35	34X34	0.6 +/- 0.1	1035-2-0772-0B-00	62.0	62.0	24.0
	773	35X35	34X34	0.6 +/- 0.1	1035-2-0773-0B-00	62.0	62.0	24.0
	780	29X29	28X28	0.6 +/- 0.1	1029-2-0780-0B-00	62.0	62.0	24.0
	783	29X29	28X28	0.6 +/- 0.1	1029-2-0783-0B-00	62.0	62.0	24.0
	784	31X31	30X30	0.66	1031-2-0784-0B-00	62.0	62.0	24.0
	812	37.5X37.5	36X36	0.6 +/- 0.1	1037-2-0812-0B-10	62.0	62.0	24.0
	829	31X31	29X29	0.63 +/- 0.1	1031-2-0829-0B-00	62.0	62.0	24.0
	840	31X31	29X29	0.7	1031-2-0840-0B-00	62.0	62.0	24.0
	868	40X40	38X38	0.6 +/- 0.08	1040-2-0868-0A-00	62.0	62.0	24.0
	899	31X31	30X30	0.6 +/- 0.1	1031-2-0899-0B-00	62.0	62.0	24.0
	960	33X33	31X31	0.6 +/- 0.1	1033-2-0960-0B-00	62.0	62.0	24.0
	993	40X40	39X39	0.6 +/- 0.1	1040-2-0993-0B-00	62.0	62.0	24.0
	1020	33X33	32X32	0.63	1033-2-1020-0B-00	62.0	62.0	24.0
	1024	33X33	32X32	0.6 +/- 0.1	1033-2-1024-0B-00	62.0	62.0	24.0
	1152	35X35	34X34	0.6 +/- 0.1	1035-2-1152-1B-00	62.0	62.0	24.0
1152	35X35	34X34	0.6 +/- 0.1	1035-2-1152-0B-00	62.0	62.0	24.0	
1152	35X35	34X34	0.6 +/- 0.1	1035-2-1152-0A-00	62.0	62.0	24.0	
1156	35X35	34X34	0.6 +/- 0.1	1035-2-1156-0B-00	62.0	62.0	24.0	
1292	37.5X37.5	36X36	0.6 +/- 0.1	1037-2-1292-0B-10	62.0	62.0	24.0	
1309	40X40	39X39	0.6 +/- 0.1	1040-2-1309-0B-00	62.0	62.0	24.0	
1369	39X39	37X37	0.6 +/- 0.1	1039-2-1369-0B-00	62.0	62.0	24.0	
1369	39X39	37X37	0.6 +/- 0.1	1039-2-1369-0B-01	62.0	62.0	24.0	
1517	40X40	39X39	0.6 +/- 0.1	1040-2-1517-0B-00	62.0	62.0	24.0	

1000-3 Series 1.27mm Pitch BGA

- Open top, vertically actuated
- Pinch and scrub contact system
- Dual moving beams per contact
- Two points of contact per solder ball
- Board mounting features
- Through hole contact
- Maintains package position for ease of handler programming

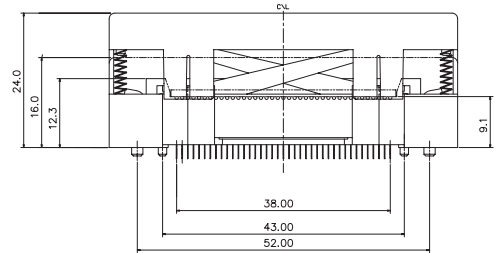
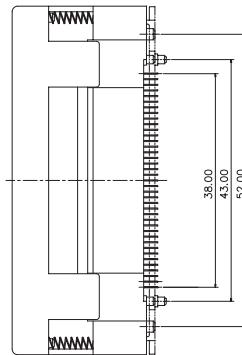
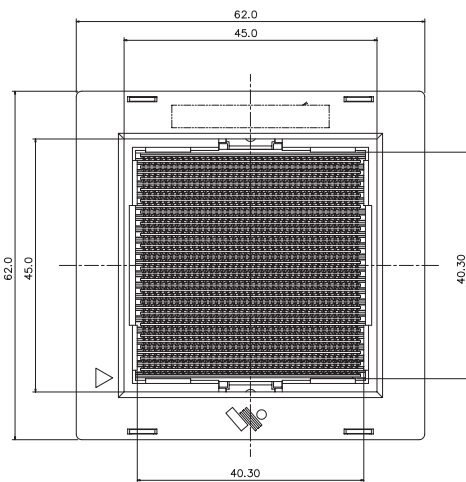
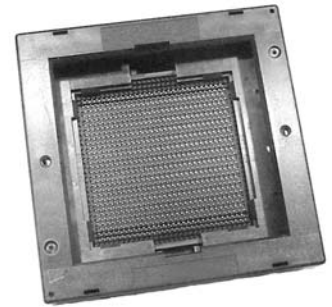

DESCRIPTION & ORDERING INFORMATION

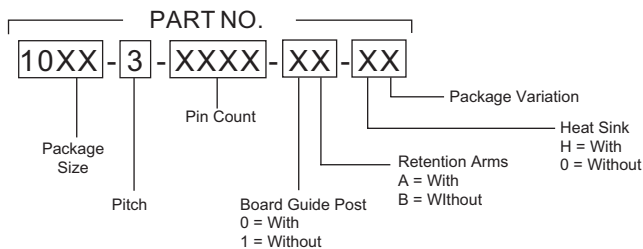

*Available contact tail lengths: 2.4mm (standard), 2.2mm, 3.4mm

MATERIALS & SPECIFICATIONS

- Socket Body and Lid: PES and LCP
- Contact: BeCu, Gold over Nickel Plated
- Metal Components: Stainless Steel
- Contact Force: 17 grams
- Actuation Force: 4Kg to 7Kg for full grid depending on socket size
- Contact Resistance: < 50 mΩ
- Dielectric Withstanding Voltage: 500V RMS
- Current Carrying Capability: 0.5A
- Insulation Resistance: > 1000 mΩ at 100V DC
- Temperature Rating: -55°C to +150°C
- Durability: 10,000 cycles (1 cycle - 1 load and 1 unload)



1000-3 Series 1.27mm Pitch BGA

Pitch e (mm)	Lead Count	Package Size	Matrix	Ball Dia. (mm)	Part Number	Socket Dimensions (mm)		
						Length (A)	Width (B)	Height (C)
1.27	115	37X15	21X11	0.76	1037-3-0115-0A-00	56.7	56.7	18.0
	119	23X17	17X7	0.75 +/- 0.1	1023-3-0119-0B-00	56.7	56.7	18.0
	119	22X14	17X17	0.75 +/- 0.15	1022-3-0119-0B-00	56.7	56.7	18.0
	119	24X14	15X8	0.76	1024-3-0119-0B-00	56.7	56.7	18.0
	120	21.5X18	14X12	0.75	1021-3-0120-0B-10	56.7	56.7	18.0
	120	23.5X21	14X12	0.75	1023-3-0120-0B-10	56.7	56.7	18.0
	125	27X27	20X20	0.75 +/- 0.15	1027-3-0125-0B-00	56.7	56.7	18.0
	153	17X23	9X17	0.75	1023-3-0153-0B-00	56.7	56.7	18.0
	156	21X21	16X16	0.75 +/- 0.15	1021-3-0156-0B-00	56.7	56.7	18.0
	156	21X21	16X16	0.75 +/- 0.15	1021-3-0156-0B-01	56.7	56.7	18.0
	159	22.25X13.25	16X10	0.75	1022-3-0159-0B-10	56.7	56.7	18.0
	177	23X23	17X17	0.75 +/- 0.15	1023-3-0177-0B-00	56.7	56.7	18.0
	197	35X35	26X26	0.75	1035-3-0197-0B-00	56.7	56.7	18.0
	208	23X23	17X17	0.75	1023-3-0208-0B-00	56.7	56.7	18.0
	208	23X23	17X17	0.75 +/- 0.1	1023-3-0208-0B-01	56.7	56.7	18.0
	218	25X25	19X19	0.75 +/- 0.1	1025-3-0218-0B-00	56.7	56.7	18.0
	218	25X25	19X19	0.75 +/- 0.1	1025-3-0218-0B-01	56.7	56.7	18.0
	219	25X25	16X16	0.76	1025-3-0219-0B-00	56.7	56.7	18.0
	225	23X23	15X15	0.75 +/- 0.1	1023-3-0225-0B-00	56.7	56.7	18.0
	233	23X23	17X17	0.75	1023-3-0233-0B-00	56.7	56.7	18.0
	240	25X30	16X18	0.75	1030-3-0240-0B-00	56.7	56.7	18.0
	241	23X23	17X17	0.75	1023-3-0241-0B-00	56.7	56.7	18.0
	252	21X21	16X16	0.75 +/- 0.15	1021-3-0252-0B-00	56.7	56.7	18.0
	255	21X21	16X16	0.835 +/- 0.05	1021-3-0255-0B-00	56.7	56.7	18.0
	256	27X27	20X20	0.70 +/- 0.1	1027-3-0256-0B-00	56.7	56.7	18.0
	256	27X27	20X20	0.70 +/- 0.1	1027-3-0256-0B-01	56.7	56.7	18.0
	256	23X23	16X16	0.75 +/- 0.1	1023-3-0256-0B-00	56.7	56.7	18.0
	256	27X27	20X20	0.70 +/- 0.1	1027-3-0256-0B-02	56.7	56.7	18.0
	271	29X29	21X21	0.60 - 0.90	1029-3-0271-0B-00	56.7	56.7	18.0
	271	29X29	21X21	0.60 - 0.90	1029-3-0271-0B-01	56.7	56.7	18.0
	272	27X27	20X20	0.75 +/- 0.15	1027-3-0272-0B-00	56.7	56.7	18.0
	280	25X25	19X19	0.71	1025-3-0280-0B-00	56.7	56.7	18.0
	292	27X27	20X20	0.75 +/- 0.15	1027-3-0292-0B-00	56.7	56.7	18.0
	304	31X31	23X23	0.75	1031-3-0304-0B-00	56.7	56.7	18.0
	308	27X27	20X20	0.75	1027-3-0308-0B-00	56.7	56.7	18.0
	313	35X35	25X25	0.75 +/- 0.1	1035-3-0313-0B-00	56.7	56.7	18.0
	316	27X27	20X20	0.75	1027-3-0316-0B-00	56.7	56.7	18.0
	320	27X27	20X20	0.75	1027-3-0320-0B-00	56.7	56.7	18.0
	324	27X27	20X20	0.75 +/- 0.15	1027-3-0324-0B-00	56.7	56.7	18.0
	324	27X27	20X20	0.75 +/- 0.15	1027-3-0324-0B-01	56.7	56.7	18.0
326	35X35	26X26	0.75	1035-3-0326-0B-00	56.7	56.7	18.0	
352	27X27	20X20	0.75	1027-3-0352-0B-00	56.7	56.7	18.0	
352	35X35	26X26	0.75	1035-3-0352-0B-00	56.7	56.7	18.0	
352	35X35	26X26	0.60 - 0.90	1035-3-0352-0A-00	56.7	56.7	18.0	
352	27X27	20X20	0.75	1027-3-0352-0B-01	56.7	56.7	18.0	
352	35X35	26X26	0.75	1035-3-0352-0A-01	56.7	56.7	18.0	
352	35X35	26X26	0.75 +/- 0.15	1035-3-0352-0B-01	56.7	56.7	18.0	
352	35X35	26X26	0.60 - 0.90	1035-3-0352-0B-02	56.7	56.7	18.0	
356	35X35	26X26	0.75	1035-3-0356-0B-00	56.7	56.7	18.0	
356	35X35	26X26	0.75	1035-3-0356-0B-01	56.7	56.7	18.0	
356	35X35	26X26	0.75	1035-3-0356-0A-00	56.7	56.7	18.0	
360	25X25	19X19	0.60 - 0.90	1025-3-0360-0B-00	56.7	56.7	18.0	
368	35X35	27X27	0.75	1035-3-0368-0B-00	56.7	56.7	18.0	
369	27X27	20X20	0.75	1027-3-0369-0B-00	56.7	56.7	18.0	

Continued on next page



1000-3 Series 1.27mm Pitch BGA

Pitch e (mm)	Lead Count	Package Size	Matrix	Ball Dia. (mm)	Part Number	Socket Dimensions (mm)		
						Length (A)	Width (B)	Height (C)
1.27	380	27X27	20X20	0.75 +/- 0.1	1027-3-0380-0B-00	56.7	56.7	18.0
	385	31X31	23X23	0.75 +/- 0.1	1031-3-0385-0B-00	56.7	56.7	18.0
	388	35X35	26X26	0.75	1035-3-0388-0B-00	56.7	56.7	18.0
	388	35X35	26X26	0.75	1035-3-0388-1B-00	56.7	56.7	18.0
	388	35X35	26X26	0.75 +/- 0.15	1035-3-0388-0B-01	56.7	56.7	18.0
	400	27X27	20X20	0.75	1027-3-0400-0B-00	56.7	56.7	18.0
	416	35X35	26X26	0.75	1035-3-0416-0B-00	56.7	56.7	18.0
	420	35X35	26X26	0.75	1035-3-0420-0B-00	56.7	56.7	18.0
	433	31X31	23X23	0.75	1031-3-0433-0B-00	56.7	56.7	18.0
	452	35X35	26X26	0.75	1035-3-0452-0B-00	56.7	56.7	18.0
	456	35X35	26X26	0.75	1035-3-0456-0B-00	56.7	56.7	18.0
	457	31X31	23X23	0.75	1031-3-0457-0B-00	56.7	56.7	18.0
	472	29X29	22X22	0.75	1029-3-0472-0B-00	56.7	56.7	18.0
	480	35X35	26X26	0.75 +/- 0.15	1035-3-0480-0B-00	56.7	56.7	18.0
	484	29X29	22X22	0.82 - 0.93	1029-3-0484-0B-00	56.7	56.7	18.0
	484	35X35	26X26	0.75 +/- 0.15	1035-3-0484-0B-00	56.7	56.7	18.0
	492	35X35	26X26	0.75	1035-3-0492-0A-10	56.7	56.7	18.0
	492	35X35	26X26	0.75	1035-3-0492-0B-00	56.7	56.7	18.0
	496	35X35	26X26	0.75	1035-3-0496-0A-00	56.7	56.7	18.0
	503	32.5X32.5	25X25	0.60 - 0.90	1032-3-0503-0B-10	56.7	56.7	18.0
	510	35X35	26X26	0.75	1035-3-0510-0B-00	56.7	56.7	18.0
	516	35X35	26X26	0.60 - 0.90	1035-3-0516-0B-00	56.7	56.7	18.0
	516	35X35	26X26	0.60 - 0.90	1035-3-0516-0B-01	56.7	56.7	18.0
	520	35X35	26X26	0.75	1035-3-0520-0B-00	56.7	56.7	18.0
	528	31X31	23X23	0.75	1031-3-0528-0B-00	56.7	56.7	18.0
	529	31X31	23X23	0.75	1031-3-0529-0B-00	56.7	56.7	18.0
	544	35X35	26X26	0.75 +/- 0.1	1035-3-0544-0B-00	56.7	56.7	18.0
	548	35X35	26X26	0.75	1035-3-0548-0A-00	56.7	56.7	18.0
	552	35X35	26X26	0.76	1035-3-0552-0B-00	56.7	56.7	18.0
	564	35X35	26X26	0.75	1035-3-0564-0B-00	56.7	56.7	18.0
	564	35X35	26X26	0.75	1035-3-0564-0A-00	56.7	56.7	18.0
	575	31X31	24X24	0.75 +/- 0.15	1031-3-0575-0B-00	56.7	56.7	18.0
	575	31X31	24X24	0.75	1031-3-0575-0B-01	56.7	56.7	18.0
	580	35X35	26X26	0.75 +/- 0.15	1035-3-0580-0B-00	56.7	56.7	18.0
	613	33X33	25X25	0.7	1033-3-0613-0B-00	56.7	56.7	18.0
	624	32.5X32.5	25X25	0.75 +/- 0.15	1032-3-0624-0B-10	56.7	56.7	18.0
	624	32.5X32.5	25X25	0.75 +/- 0.15	1032-3-0624-0B-11	56.7	56.7	18.0
	624	32.5X32.5	25X25	0.75 +/- 0.15	1032-3-0624-0B-12	56.7	56.7	18.0
	624	32.33X32.33	25X25	0.89 +/- 0.4	1032-3-0624-0B-13	56.7	56.7	18.0
	637	35X35	27X27	0.75	1035-3-0637-0B-00	56.7	56.7	18.0
676	35X35	26X26	0.75	1035-3-0676-0A-00	56.7	56.7	18.0	
676	35X35	26X26	0.75 +/- 0.025	1035-3-0676-0B-00	56.7	56.7	18.0	
676	35X35	26X26	0.75 +/- 0.15	1035-3-0676-0B-01	56.7	56.7	18.0	
729	35X35	27X27	0.75 +/- 0.05	1035-3-0729-0B-00	56.7	56.7	18.0	
729	35X35	27X27	0.75	1035-3-0729-0B-01	56.7	56.7	18.0	
80	40X40	31X31	0.76 +/- 0.14	1040-3-0080-0A-00	69.1	69.1	20.5	
397	45X45	34X34	0.75 +/- 0.1	1045-3-0397-0B-00	69.1	69.1	20.5	
432	40X40	31X31	0.75	1040-3-0432-0B-00	69.1	69.1	20.5	
432	40X40	31X31	0.75	1040-3-0432-0B-01	69.1	69.1	20.5	
480	37.5X37.5	29X29	0.65 - 0.85	1037-3-0480-0B-10	69.1	69.1	20.5	
480	37.5X37.5	29X29	0.75 +/- 0.15	1037-3-0480-0B-11	69.1	69.1	20.5	
500	37.5X37.5	28X28	0.76 +/- 0.14	1037-3-0500-0B-10	69.1	69.1	20.5	
504	37.5X37.5	29X29	0.75 +/- 0.15	1037-3-0504-0B-10	69.1	69.1	20.5	
504	40X40	29X29	0.75 +/- 0.15	1040-3-0504-0B-00	69.1	69.1	20.5	

Continued on next page



1000-3 Series 1.27mm Pitch BGA

Pitch e (mm)	Lead Count	Package Size	Matrix	Ball Dia. (mm)	Part Number	Socket Dimensions (mm)		
						Length (A)	Width (B)	Height (C)
1.27	519	40X40	31X31	0.76 +/- 0.05	1040-3-0519-0B-00	69.1	69.1	20.5
	520	40X40	31X31	0.75	1040-3-0520-0B-00	69.1	69.1	20.5
	553	37.5X37.5	29X29	0.75 +/- 0.1	1037-3-0553-0B-10	69.1	69.1	20.5
	560	42.50X42.50	33X33	0.75	1042-3-0560-0B-10	69.1	69.1	20.5
	560	42.5X42.5	33X33	0.75	1042-3-0560-0B-11	69.1	69.1	20.5
	560	42.5X42.5	31X31	0.75 +/- 0.15	1042-3-0560-0B-12	69.1	69.1	20.5
	596	40X40	30X30	0.73	1040-3-0596-0B-00	69.1	69.1	20.5
	600	40X40	31X31	0.75	1040-3-0600-0B-00	69.1	69.1	20.5
	600	45X45	35X35	0.60 - 0.90	1045-3-0600-0B-00	69.1	69.1	20.5
	608	40X40	27X27	0.76	1040-3-0608-0B-00	69.1	69.1	20.5
	609	42.5X42.5	33X33	0.75 +/- 0.1	1042-3-0609-0B-10	69.1	69.1	20.5
	625	37.5X37.5	29X29	0.79 +/- 0.05	1037-3-0625-0B-10	69.1	69.1	20.5
	640	37.5X37.5	28X28	0.78	1037-3-0640-0B-10	69.1	69.1	20.5
	643	45X45	34X34	0.787	1045-3-0643-0B-00	69.1	69.1	20.5
	672	40X40	31X31	0.75	1040-3-0672-0B-00	69.1	69.1	20.5
	673	37.5X37.5	29X29	0.75 +/- 0.1	1037-3-0673-0B-10	69.1	69.1	20.5
	686	37.5X37.5	29X29	0.75 +/- 0.15	1037-3-0686-0B-10	69.1	69.1	20.5
	696	45X45	35X35	0.75 +/- 0.15	1045-3-0696-0B-00	69.1	69.1	20.5
	713	40X40	31X31	0.76	1040-3-0713-0B-00	69.1	69.1	20.5
	725	40X40	27X27	0.75 +/- 0.1	1040-3-0725-0B-00	69.1	69.1	20.5
	760	40X40	30X30	0.75 +/- 0.15	1040-3-0760-0B-00	69.1	69.1	20.5
	769	42.5X42.5	33X33	0.76	1042-3-0769-0B-10	69.1	69.1	20.5
	785	37.5X37.5	29X29	0.75 +/- 0.15	1037-3-0785-0B-10	69.1	69.1	20.5
	817	42.5X42.5	33X33	0.76	1042-3-0817-0B-10	69.1	69.1	20.5
	824	42.5X32.5	33X25	0.75 +/- 0.15	1042-3-0824-0B-10	69.1	69.1	20.5
	841	37.5X37.5	29X29	0.75 +/- 0.15	1037-3-0841-0B-10	69.1	69.1	20.5
	900	40X40	30X30	0.75 +/- 0.15	1040-3-0900-0B-00	69.1	69.1	20.5
	957	40X40	31X31	0.75 +/- 0.15	1040-3-0957-0B-00	69.1	69.1	20.5
	961	40X40	31X31	0.76 +/- 0.14	1040-3-0961-0B-00	69.1	69.1	20.5
	976	45X45	34X34	0.75 +/- 0.15	1045-3-0976-0B-00	69.1	69.1	20.5
1024	42.5X42.5	32X32	0.75	1042-3-1024-0B-10	69.1	69.1	20.5	
1072	45X45	34X34	0.7	1045-3-1072-0B-00	69.1	69.1	20.5	
1152	45X45	34X34	0.75 +/- 0.15	1045-3-1152-0B-00	69.1	69.1	20.5	
1156	45X45	34X34	0.75	1045-3-1156-0B-00	69.1	69.1	20.5	
1225	45X45	35X35	0.75	1045-3-1225-0B-00	69.1	69.1	20.5	

1100-2 Series 1.00mm Pitch BGA/LGA

- Clamshell design
- Through hole contact tails
- Two points of contact per solder ball
- Board mounting features
- Low normal force
- 10:1 Mechanical Advantage lid for high ball count packages available

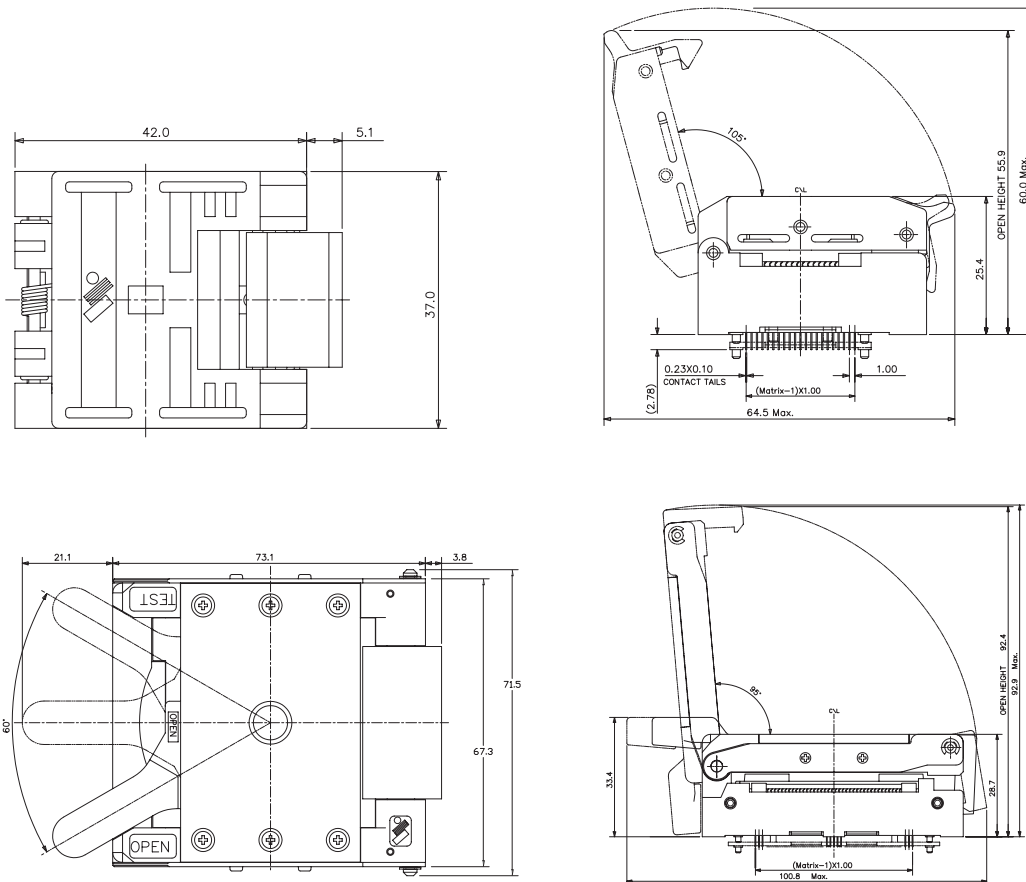
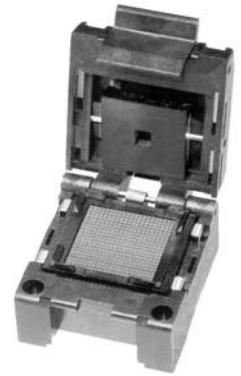

DESCRIPTION & ORDERING INFORMATION

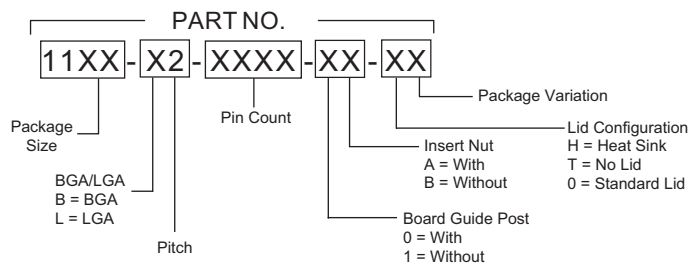

MATERIALS & SPECIFICATIONS

- Socket Body and Lid: PES and LCP
- Contact: BeCu, Gold over Nickel Plated
- Metal Components: Stainless Steel (Optional Threaded Insert: Brass)
- Contact Force: 36 grams
- Contact Resistance: < 100 mΩ
- Dielectric Withstanding Voltage: 500V RMS
- Current Carrying Capability: 1.0A
- Insulation Resistance: > 1000 mΩ at 500V DC
- Temperature Rating: -55°C to +150°C
- Durability: 5,000 cycles (1 cycle - 1 load and 1 unload)

*Available contact tail lengths: 2.8mm (standard), 3.18mm (added cost for machined standoffs), 3.8mm (available for 47.5mm packages and larger only)



1100-2 Series 1.00mm Pitch BGA/LGA

Pitch e (mm)	Lead Count	Package Size	Matrix	Ball Dia. (mm)	Part Number	Socket Dimensions (mm)	
						Length (A)	Width (B)
1.00	24	6X8	5X5	0.46	1108-B2-0024-0A-00	37.0	47.1
	25	5X5	5X5	0.56	1105-B2-0025-0B-00	37.0	47.1
	36	17X12	11X9	0.5	1117-L2-0036-0B-00	37.0	47.1
	40	22X22	21X21	0.75	1122-L2-0040-0B-00	37.0	47.1
	48	10X12	6X8	0.55 +/- 0.05	1112-B2-0048-0B-00	37.0	47.1
	49	7.25X7.25	7X7	0.59	1107-L2-0049-0A-10	37.0	47.1
	64	8X8	8X8	0.61	1108-B2-0064-0B-00	37.0	47.1
	68	12X12	10X10	0.6	1112-L2-0068-0B-00	37.0	47.1
	68	12X12	10X10	0.6	1112-L2-0068-0B-01	37.0	47.1
	84	10X10	10X10	0.5	1110-B2-0084-0B-00	37.0	47.1
	99	12X18	9X11	0.60 +/- 0.1	1118-L2-0099-0B-00	37.0	47.1
	100	11X11	10X10	0.56	1111-B2-0100-0B-00	37.0	47.1
	100	11X11	10X10	0.52	1111-B2-0100-0B-01	37.0	47.1
	100	10X10	10X10	0.56	1110-B2-0100-0B-00	37.0	47.1
	156	15X15	14X14	0.5	1115-B2-0156-0A-00	37.0	47.1
	169	13X13	13X13	0.56	1113-B2-0169-0B-00	37.0	47.1
	169	13X13	13X13	0.4	1113-B2-0169-0B-01	37.0	47.1
	169	13X13	13X13	0.56	1113-B2-0169-0B-02	37.0	47.1
	196	15X15	14X14	0.35 - 0.65	1115-B2-0196-0A-00	37.0	47.1
	208	17X17	16X16	0.5	1117-B2-0208-0B-00	37.0	47.1
	220	21X21	20X20	0.56	1121-B2-0220-0A-00	37.0	47.1
	228	17X17	16X16	0.55	1117-L2-0228-0B-00	37.0	47.1
	256	17X17	16X16	0.5	1117-B2-0256-0B-00	37.0	47.1
	256	17X17	16X16	0.5	1117-B2-0256-0A-00	37.0	47.1
	256	17X17	16X16	0.6 +/- 0.1	1117-B2-0256-0A-01	37.0	47.1
	256	17X17	16X16	0.6 +/- 0.1	1117-B2-0256-0A-02	37.0	47.1
	256	17X17	16X16	0.6 +/- 0.1	1117-B2-0256-0B-01	37.0	47.1
	289	23X23	17X17	0.5	1123-B2-0289-0B-00	37.0	47.1
	144	12X17	911	0.4	1117-B2-0144-0A-00	52.0	71.9
	276	27X27	26X26	0.50 - 0.70	1127-B2-0276-0B-00	52.0	71.9
	324	23X23	22X22	0.50 +/- 0.1	1123-B2-0324-0B-00	52.0	71.9
	324	23X23	22X22	0.6 +/- 0.1	1123-B2-0324-0A-00	52.0	71.9
	324	23X23	22X22	0.6 +/- 0.1	1123-B2-0324-0B-01	52.0	71.9
	324	23X23	22X22	0.6 +/- 0.1	1123-B2-0324-0A-01	52.0	71.9
	324	31X31	30X30	0.63 +/- 0.13	1131-B2-0324-0A-00	52.0	71.9
	352	27X27	26X26	0.6 +/- 0.1	1127-B2-0352-0A-00	52.0	71.9
	357	37.5X37.5	37X37	0.6	1137-B2-0357-0A-10	52.0	71.9
	359	37.5X37.5	37X37	0.6	1137-B2-0359-0A-10	52.0	71.9
	360	35X35	33X33	0.50 - 0.70	1135-B2-0360-0B-00	52.0	71.9
	376	23X23	22X22	0.6	1123-B2-0376-0A-00	52.0	71.9
	388	27X27	26X26	0.6 +/- 0.1	1127-B2-0388-0A-00	52.0	71.9
	416	27X27	26X26	0.6	1127-B2-0416-0A-00	52.0	71.9
	416	31X31	30X30	0.63	1131-B2-0416-0B-00	52.0	71.9
	456	27X27	26X26	0.63	1127-B2-0456-0A-00	52.0	71.9
	456	27X27	26X26	0.63	1127-B2-0456-0A-01	52.0	71.9
	456	23X23	22X22	0.6	1123-B2-0456-0A-00	52.0	71.9
	456	23X23	22X22	0.63 +/- 0.07	1123-B2-0456-0A-01	52.0	71.9
	480	35X35	34X34	0.6	1135-B2-0480-0B-00	52.0	71.9
480	35X35	34X34	0.63 +/- 0.13	1135-B2-0480-0A-00	52.0	71.9	
484	23X23	22X22	0.6	1123-B2-0484-0A-00	52.0	71.9	
484	23X23	22X22	0.6	1123-B2-0484-0A-01	52.0	71.9	
484	23X23	22X22	0.6	1123-B2-0484-0B-00	52.0	71.9	
484	31X31	26X26	0.5	1131-B2-0484-0B-00	52.0	71.9	
487	40X40	38X38	0.6	1140-B2-0487-1B-00	52.0	71.9	

Continued on next page



1100-2 Series 1.00mm Pitch BGA/LGA

Pitch e (mm)	Lead Count	Package Size	Matrix	Ball Dia. (mm)	Part Number	Socket Dimensions (mm)	
						Length (A)	Width (B)
1.00	560	40X40	39X39	0.63	1140-B2-0560-0A-00	52.0	71.9
	576	31X31	30X30	0.6 +/- 0.1	1131-B2-0576-0A-00	52.0	71.9
	580	35X35	34X34	0.63 +/- 0.12	1135-B2-0580-0A-00	52.0	71.9
	580	35X35	34X34	0.65	1135-B2-0580-0B-00	52.0	71.9
	580	31X31	30X30	0.6 +/- 0.1	1131-B2-0580-0B-00	52.0	71.9
	604	31X31	30X30	0.6 +/- 0.1	1131-B2-0604-0A-00	52.0	71.9
	620	37.5X37.5	36X36	0.64 +/- 0.1	1137-B2-0620-0A-10	52.0	71.9
	625	27X27	25X25	0.6 +/- 0.1	1127-B2-0625-0A-00	52.0	71.9
	636	31X31	30X30	0.6 +/- 0.1	1131-B2-0636-0A-00	52.0	71.9
	640	31X31	30X30	0.6 +/- 0.1	1131-B2-0640-0A-00	52.0	71.9
	672	27X27	26X26	0.6 +/- 0.1	1127-B2-0672-0A-00	52.0	71.9
	672	35X35	34X34	0.55	1135-B2-0672-0A-00	52.0	71.9
	676	27X27	26X26	0.6	1127-B2-0676-0B-00	52.0	71.9
	676	27X27	26X26	0.6	1127-B2-0676-0A-00	52.0	71.9
	676	27X27	26X26	0.63	1127-B2-0676-0A-01	52.0	71.9
	676	27X27	26X26	0.6	1127-B2-0676-0B-01	52.0	71.9
	676	27X27	26X26	0.5	1127-L2-0676-0B-00	52.0	71.9
	676	31X31	30X30	0.6	1131-B2-0676-0A-00	52.0	71.9
	680	35X35	34X34	0.64	1135-B2-0680-0B-00	52.0	71.9
	680	40X40	39X39	0.63	1140-B2-0680-0A-00	52.0	71.9
	680	40X40	39X39	0.6	1140-B2-0680-0A-01	52.0	71.9
	680	35X35	34X34	0.6	1135-B2-0680-0A-00	52.0	71.9
	680	35X35	34X34	0.64	1135-B2-0680-0B-01	52.0	71.9
	680	35X35	34X34	0.6	1135-B2-0680-0A-01	52.0	71.9
	688	35X35	34X34	0.6	1135-B2-0688-0A-00	52.0	71.9
	692	31X31	30X30	0.6 +/- 0.1	1131-B2-0692-0A-00	52.0	71.9
	701	31X31	30X30	0.6 +/- 0.1	1131-B2-0701-0A-00	52.0	71.9
	708	35X35	34X34	0.6	1135-B2-0708-0A-00	52.0	71.9
	728	40X40	38X38	0.65 +/- 0.03	1140-B2-0728-0A-00	52.0	71.9
	740	35X35	34X34	0.65 +/- 0.1	1135-B2-0740-0A-00	52.0	71.9
	768	40X40	38X38	0.6 +/- 0.1	1140-B2-0768-0A-00	52.0	71.9
	788	35X35	34X34	0.6	1135-B2-0788-0A-00	52.0	71.9
	792	40X40	39X39	0.6	1140-B2-0792-0A-00	52.0	71.9
	792	40X40	39X39	0.6	1140-B2-0792-0A-01	52.0	71.9
	801	35X35	34X34	0.6 +/- 0.1	1135-B2-0801-0A-00	52.0	71.9
	812	37.5X37.5	36X36	0.63	1137-B2-0812-0A-10	52.0	71.9
	816	35X35	34X34	0.6	1135-B2-0816-0A-00	52.0	71.9
	824	37.5X37.5	36X36	0.6 +/- 0.1	1137-B2-0824-0A-10	52.0	71.9
	829	31X31	29X29	0.63 +/- 0.1	1131-B2-0829-0A-00	52.0	71.9
	840	37.5X37.5	36X36	0.6 +/- 0.1	1137-B2-0840-0A-10	52.0	71.9
	840	31X31	29X29	0.7 +/- 0.05	1131-B2-0840-0A-00	52.0	71.9
	840	31X31	29X29	0.7 +/- 0.05	1131-B2-0840-0A-01	52.0	71.9
854	40X40	39X39	0.6	1140-B2-0854-0A-00	52.0	71.9	
896	31X31	30X30	0.60 +/- 0.1	1131-B2-0896-0A-00	52.0	71.9	
896	31X31	30X30	0.63 +/- 0.07-0.13	1131-B2-0896-0A-01	52.0	71.9	
899	31X31	30X30	0.6 +/- 0.1	1131-B2-0899-0A-00	52.0	71.9	
900	31X31	30X30	0.60 +/- 0.1	1131-B2-0900-0B-00	52.0	71.9	
901	37.5X37.5	36X36	0.6	1137-B2-0901-0A-10	52.0	71.9	
937	33X33	31X31	0.711 +/- 0.05	1133-B2-0937-0A-00	52.0	71.9	
956	35X35	34X34	0.6 +/- 0.1	1135-B2-0956-0A-00	52.0	71.9	
956	35X35	34X34	0.6 +/- 0.1	1135-B2-0956N0A-00	52.0	71.9	
980	35X35	32X32	0.508	1135-L2-0980-0B-00	52.0	71.9	
992	40X40	39X39	0.6 +/- 0.1	1140-B2-0992-0A-00	52.0	71.9	
993	40X40	39X39	0.6 +/- 0.1	1140-B2-0993N0B-00	52.0	71.9	

Continued on next page



1100-2 Series 1.00mm Pitch BGA/LGA

Pitch e (mm)	Lead Count	Package Size	Matrix	Ball Dia. (mm)	Part Number	Socket Dimensions (mm)	
						Length (A)	Width (B)
1.00	1012	40X40	38X38	0.6	1140-B2-1012-0A-00	52.0	71.9
	1012	40X40	38X38	0.63	1140-B2-1012-0B-00	52.0	71.9
	1140	40X40	39X39	0.6	1140-B2-1140-0A-00	52.0	71.9
	1144	35X35	34X34	0.7	1135-L2-1144-0A-00	52.0	71.9
	1152	35X35	34X34	0.6	1135-B2-1152-0A-00	52.0	71.9
	1152	35X35	34X34	0.64	1135-B2-1152-0A-01	52.0	71.9
	1152	35X35	34X34	0.63	1135-B2-1152-0A-02	52.0	71.9
	1156	35X35	34X34	0.6	1135-B2-1156-0B-00	52.0	71.9
	1156	35X35	34X34	0.6	1135-B2-1156-0A-00	52.0	71.9
	1156	35X35	34X34	0.6	1135-B2-1156-0A-01	52.0	71.9
	1156	35X35	34X34	0.6 +/- 0.1	1135-B2-1156-0B-01	52.0	71.9
	1157	40X40	39X39	0.64 +/- 0.1	1140-B2-1157-0A-00	52.0	71.9
	1296	37.5X37.5	36X36	0.60 +/- 0.1	1137-B2-1296-0A-10	52.0	71.9
	1296	37.5X37.5	36X36	0.6 +/- 0.1	1137-B2-1296-0A-11	52.0	71.9
	1296	37.5X37.5	36X36	0.6 +/- 0.1	1137-B2-1296-0B-10	52.0	71.9
	1309	40X40	39X39	0.6	1140-B2-1309N0A-00	52.0	71.9
	1413	40X40	39X39	0.6 +/- 0.1	1140-B2-1413-0A-00	52.0	71.9
	1417	40X40	39X39	0.6	1140-B2-1417-0B-00	52.0	71.9
	1428	40X40	39X39	0.6	1140-B2-1428-0A-00	52.0	71.9
	1444	4X040	38X38	0.60 +/- 0.03	1140-B2-1444-0B-00	52.0	71.9
	1517	40X40	39X39	0.6	1140-B2-1517-0A-00	52.0	71.9
	1520	40X40	39X39	0.5	1140-B2-1520-0B-00	52.0	71.9
	836	42.5X42.5	41X41	0.63	1142-B2-0836-0A-10	65.3	98.0
	840	42.5X42.5	41X41	0.6	1142-B2-0840-0A-10	65.3	98.0
	1036	45X45	44X44	0.6 +/- 0.1	1145-B2-1036-0A-00	65.3	98.0
	1125	42.5X42.5	41X41	0.6 +/- 0.1	1142-B2-1125-0A-10	65.3	98.0
	1144	35X35	34X34	0.7 +/- 0.1	1135-L2-1144-0A-00	65.3	98.0
	1517	40X40	39X39	0.6 +/- 0.1	1140-B2-1517-0A-00	65.3	98.0
	1521	40X40	39X39	0.50 - 0.70	1140-B2-1521-0A-00	65.3	98.0
	1932	45X45	44X44	0.64	1145-B2-1932-0A-00	65.3	98.0

1100-3 Series 1.27mm Pitch Lidded BGA/LGA

- Clamshell design
- Through hole contact tails
- Board mounting features
- Low normal force
- 10:1 Mechanical advantage lid for high ball count packages available
- Low profile lids available

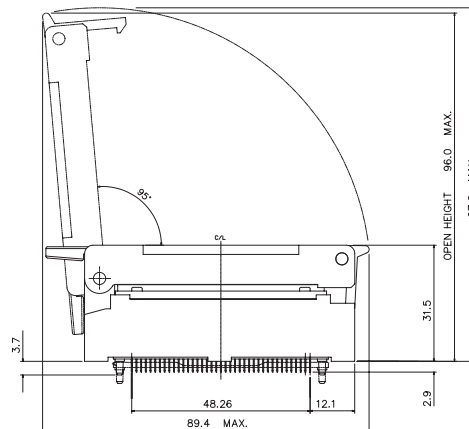
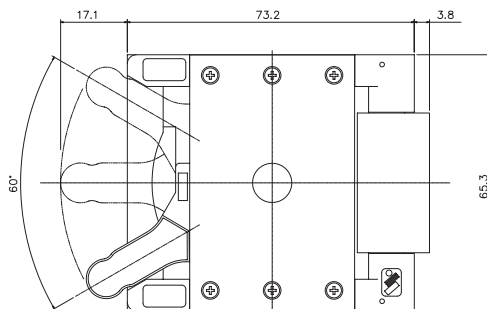
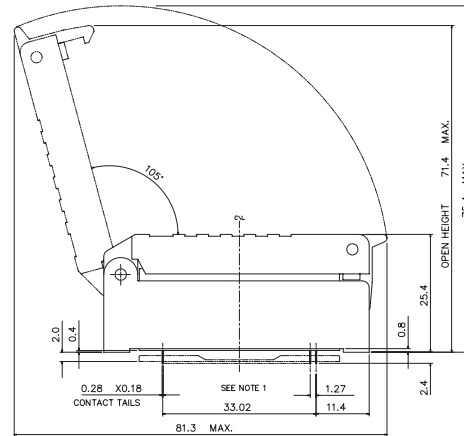
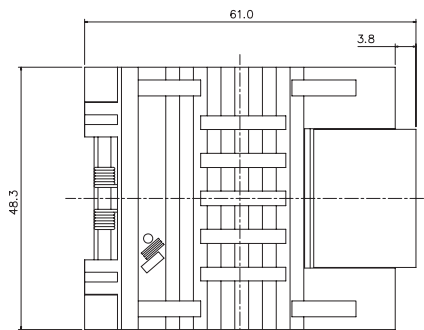

DESCRIPTION & ORDERING INFORMATION

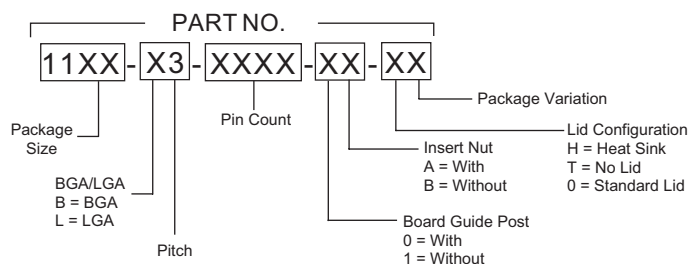

MATERIALS & SPECIFICATIONS

- Socket Body and Lid: PES and LCP
- Contact: BeCu, Gold over Nickel Plated
- Metal Components: Stainless Steel
- Contact Force: 30 grams to 50 grams
- Dielectric Withstanding Voltage: 1000V RMS
- Current Carrying Capability: 1.0A
- Insulation Resistance: > 1000 mΩ at 500V DC
- Temperature Rating: -55°C to +150°C
- Durability: 5,000 cycles (1 cycle - 1 load and 1 unload)

*Available contact tail lengths: 2.4mm length only



1100-3 Series 1.27mm Pitch Lidded BGA/LGA

Pitch e (mm)	Lead Count	Package Size	Matrix	Ball Dia. (mm)	Part Number	Socket Dimensions (mm)	
						Length (A)	Width (B)
1.27	24	10.16X11.94	6X8	0.68 - 0.90	1111-B3-0024-1B-10	42.6	31.0
	34	14X10.2	8X11	0.635	1112-B3-0034-1B-10	42.6	31.0
	44	10.16X10.16	8X8	0.68 - 0.90	1110-B3-0044-1B-10	42.6	31.0
	121	15X15	11X11	0.5 +/- 0.05	1115-B3-0121-1B-00	42.6	31.0
	176	23X23	15X15	0.68 - 0.90	1123-B3-0176-1B-00	42.6	31.0
	225	23X23	15X15	0.68 - 0.90	1123-B3-0225-1B-00	42.6	31.0
	62	23X23	15X15	0.68 - 0.90	1123-L3-0062-1B-00	61.0	48.3
	84	23X23	15X15	0.68 - 0.90	1123-L3-0084-1B-00	61.0	48.3
	156	21X21	16X16	0.68 - 0.90	1121-B3-0156-1B-00	61.0	48.3
	156	21X21	16X16	0.68 - 0.90	1121-B3-0156-0B-00	61.0	48.3
	208	23X23	17X17	0.68 - 0.90	1123-B3-0208-0B-00	61.0	48.3
	208	23X23	17X17	0.68 - 0.90	1123-B3-0208-1B-00	61.0	48.3
	208	23X23	17X17	0.68 - 0.90	1123-B3-0208-0B-01	61.0	48.3
	208	23X23	17X17	0.68 - 0.90	1123-B3-0208-0B-02	61.0	48.3
	208	23x23	17x17	0.68 - 0.90	1123-B3-0208-1B-01	61.0	48.3
	208	23x23	17x17	0.75 +/- 0.15	1123-B3-0208-0B-03	61.0	48.3
	228	21X21	16X16	0.68 - 0.90	1121-B3-0228-1B-00	61.0	48.3
	256	27X27	20X20	0.68 - 0.90	1127-B3-0256-1B-00	61.0	48.3
	256	23X23	16X16	0.75	1123-B3-0256-1B-00	61.0	48.3
	256	27X27	20X20	0.68 - 0.90	1127-B3-0256-0A-00	61.0	48.3
	256	27X27	20X20	0.68 - 0.90	1127-B3-0256-1B-01	61.0	48.3
	256	27X27	20X20	0.68 - 0.90	1127-B3-0256-0B-00	61.0	48.3
	256	27X27	20X20	0.76	1127-B3-0256-0A-01	61.0	48.3
	256	27X27	20X20	0.68 - 0.90	1127-B3-0256-1B-02	61.0	48.3
	256	27X27	20X20	0.76 +/- 0.15	1127-B3-0256-0A-02	61.0	48.3
	256	27X27	20X20	0.8	1127-B3-0256-0B-01	61.0	48.3
	256	23X23	16X16	0.68 - 0.90	1123-B3-0256-1B-01	61.0	48.3
	256	21X21	16X16	0.68 - 0.90	1121-B3-0256-1B-00	61.0	48.3
	256	23X23	16X16	0.9	1123-L3-0256-0B-00	61.0	48.3
	256	30X30	23X23	0.68 - 0.90	1130-B3-0256-1B-00	61.0	48.3
	256	30X30	23X23	0.68 - 0.90	1130-B3-0256-0B-00	61.0	48.3
	272	27X27	20X20	0.68 - 0.90	1127-B3-0272-1B-00	61.0	48.3
	292	27X27	20X20	0.68 - 0.90	1127-B3-0292-1B-00	61.0	48.3
	300	25X25	19X19	0.9	1125-B3-0300-1B-00	61.0	48.3
	304	31X31	23X23	0.68 - 0.90	1131-B3-0304-0A-00	61.0	48.3
	304	31X31	23X23	0.68 - 0.90	1131-B3-0304-1B-00	61.0	48.3
304	31X31	23X23	0.75	1131-B3-0304-0A-01	61.0	48.3	
380	27X27	20X20	0.68 - 0.90	1127-B3-0380-1B-00	61.0	48.3	
313	35X35	25X25	0.68 - 0.90	1135-B3-0313-1B-00	61.0	48.3	
313	35X35	25X25	0.68 - 0.90	1135-B3-0313-1B-01	61.0	48.3	
324	27X27	20X20	0.68 - 0.90	1127-B3-0324-1B-00	61.0	48.3	
336	27X27	20X20	0.68 - 0.90	1127-B3-0336-1B-00	61.0	48.3	
352	35X35	26X26	0.68 - 0.90	1135-B3-0352-1B-00	61.0	48.3	
352	35X35	26X26	0.68 - 0.90	1135-B3-0352-0B-00	61.0	48.3	
352	35X35	26X26	0.68 - 0.90	1135-B3-0352-0B-01	61.0	48.3	
357	25x25	19x19	0.68 - 0.90	1125-B3-0357-0B-00	61.0	48.3	
357	25X25	19X19	0.68 - 0.90	1125-B3-0357-1B-00	61.0	48.3	
361	24.76X24.76	19X19	0.68 - 0.90	1124-B3-0361-1B-10	61.0	48.3	

Continued on next page



1100-3 Series 1.27mm Pitch Lidded BGA

Pitch e (mm)	Lead Count	Package Size	Matrix	Ball Dia. (mm)	Part Number	Socket Dimensions (mm)	
						Length (A)	Width (B)
1.27	361	25X25	19X19	0.68 - 0.90	1125-L3-0361-1B-00	61.0	48.3
	380	31X31	24X24	0.75	1131-B3-0380-0A-00	61.0	48.3
	388	35X35	26X26	0.68 - 0.90	1135-B3-0388-1B-00	61.0	48.3
	388	35X35	26X26	0.68 - 0.90	1135-B3-0388-0A-00	61.0	48.3
	400	27X27	20X20	0.68 - 0.90	1127-B3-0400-1B-00	61.0	48.3
	436	35X35	26X26	0.68 - 0.90	1135-B3-0436-1B-00	61.0	48.3
	456	35X35	26X26	0.68 - 0.90	1135-B3-0456-1B-00	61.0	48.3
	456	35X35	26X26	0.68 - 0.90	1135-B3-0456-0B-00	61.0	48.3
	456	35X35	26X26	0.68 - 0.90	1135-B3-0456-1B-01	61.0	48.3
	676	35X35	26X26	0.68 - 0.90	1135-B3-0676-1B-00	61.0	48.3
	208	23X23	17X17	0.68 - 0.90	1123-B3-0208-1B-00	62.1	48.3
	256	27X27	20X20	0.68 - 0.90	1127-B3-0256-0A-01	62.1	48.3
	256	27X27	20X20	0.68 - 0.90	1127-B3-0256-0A-00	62.1	48.3
	256	23X23	16X16	0.75 +/- 0.1	1123-B3-0256-0A-00	62.1	48.3
	272	27X27	20X20	0.68 - 0.90	1127-B3-0272-0A-00	62.1	48.3
	292	27X27	18X18	0.75	1127-B3-0292-0A-00	62.1	48.3
	304	31X31	23X23	0.68 - 0.90	1131-B3-0304-1B-00	62.1	48.3
	357	25X25	19X19	0.75 +/- 0.1	1125-B3-0357-0A-00	62.1	48.3
	360	25X25	19X19	0.86 +/- 0.05	1125-L3-0360-0A-00	62.1	48.3
	365	31X31	23X23	0.68 - 0.90	1131-B3-0365-0A-00	62.1	48.3
	380	27X27	20X20	0.68 - 0.90	1127-B3-0380-0A-00	62.1	48.3
	388	35X35	26X26	0.75 +/- 0.05	1135-B3-0388-0A-00	62.1	48.3
	420	35X35	26X26	0.75	1135-B3-0420-0A-00	62.1	48.3
	456	35X35	26X26	0.68 - 0.90	1135-B3-0456-0A-00	62.1	48.3
	717	35X35	27X27	0.86 +/- 0.13	1135-L3-0717-0A-00	62.1	48.3
	217	23X23	17X17	0.68 - 0.90	1123-B3-0217-1B-00	71.9	48.3
	217	23X23	17X17	0.68 - 0.90	1123-B3-0217-0A-00	71.9	48.3
	217	23X23	17X17	0.68 - 0.90	1123-B3-0217-0A-01	71.9	48.3
	217	23X23	17X17	0.68 - 0.90	1123-B3-0217-0A-02	71.9	48.3
	240	25X25	19X19	0.75	1125-B3-0240-0A-00	71.9	48.3
	255	21X21	16X16	0.68 - 0.90	1121-B3-0255-1B-00	71.9	48.3
	256	27X27	20X20	0.68 - 0.90	1127-B3-0256-1B-00	71.9	48.3
	256	27X27	20X20	0.68 - 0.90	1127-B3-0256-1B-01	71.9	48.3
	256	27X27	20X20	0.68 - 0.90	1127-B3-0256-1B-02	71.9	48.3
	256	27X27	20X20	0.68 - 0.90	1127-B3-0256-1B-03	71.9	48.3
	256	21X21	16X16	0.68 - 0.90	1121-B3-0256-1B-00	71.9	48.3
	256	30X30	23X23	0.68 - 0.90	1130-B3-0256-1B-00	71.9	48.3
	272	27X27	20X20	0.68 - 0.90	1127-B3-0272-1B-00	71.9	48.3
	272	27X27	20X20	0.75	1127-B3-0272-0A-00	71.9	48.3
	272	27X27	20X20	0.75	1127-B3-0272-0A-01	71.9	48.3
	272	27X27	20X20	0.75	1127-B3-0272-0A-02	71.9	48.3
	280	25X25	19X19	0.68 - 0.90	1125-B3-0280-0A-00	71.9	48.3
	292	27X27	20X20	0.68 - 0.90	1127-B3-0292-1B-00	71.9	48.3
	292	27X27	20X20	0.75	1127-B3-0292-1B-01	71.9	48.3
	292	27X27	20X20	0.68 - 0.90	1127-B3-0292-1B-02	71.9	48.3
303	20.95X24.70	16X19	0.68 - 0.90	1124-B3-0303-1B-10	71.9	48.3	
313	35X35	25X25	0.68 - 0.90	1135-B3-0313-1B-00	71.9	48.3	
313	35X35	25X25	0.75	1135-B3-0313-0A-00	71.9	48.3	
316	27X27	20X20	0.7	1127-B3-0316-0A-00	71.9	48.3	
324	27x27	20x20	0.68 - 0.90	1127-B3-0324-1B-00	71.9	48.3	
339	31x31	22x22	0.68 - 0.90	1131-B3-0339-1B-00	71.9	48.3	

Continued on next page



1100-3 Series 1.27mm Pitch Lidded BGA/LGA

Pitch e (mm)	Lead Count	Package Size	Matrix	Ball Dia. (mm)	Part Number	Socket Dimensions (mm)	
						Length (A)	Width (B)
1.27	352	35x35	26x26	0.75	1135-B3-0352-1B-00	71.9	48.3
	352	35x35	26x26	0.75	1135-B3-0352-1B-01	71.9	48.3
	352	35x35	26x26	0.68 - 0.90	1135-B3-0352-0A-00	71.9	48.3
	352	35x35	26x26	0.75 +/- 0.15	1135-B3-0352-0A-01	71.9	48.3
	352	35x35	26x26	0.75 +/- 0.1	1135-B3-0352-0A-02	71.9	48.3
	352	35x35	26x26	0.75	1135-B3-0352-0A-03	71.9	48.3
	356	35x35	26x26	0.68 - 0.90	1135-B3-0356-0A-00	71.9	48.3
	356	35x35	26x26	0.68 - 0.90	1135-B3-0356-1B-00	71.9	48.3
	357	25x25	19x19	0.68 - 0.90	1125-B3-0357-1B-00	71.9	48.3
	357	25x25	19x19	0.68 - 0.90	1125-B3-0357-1B-01	71.9	48.3
	360	25x25	19x19	0.68 - 0.90	1125-B3-0360-1B-00	71.9	48.3
	360	25x25	19x19	0.68 - 0.90	1125-L3-0360-1B-00	71.9	48.3
	360	25x25	19x19	0.68 - 0.90	1125-B3-0360-1B-01	71.9	48.3
	360	25x25	19x19	0.75	1125-B3-0360-0B-00	71.9	48.3
	360	31x31	23x23	0.75	1131-B3-0360-0B-00	71.9	48.3
	372	27x27	20x20	0.76	1127-B3-0372-0B-00	71.9	48.3
	379	33x33	24x24	0.68 - 0.90	1133-B3-0379-0A-00	71.9	48.3
	385	31x31	23x23	0.68 - 0.90	1131-B3-0385-0B-00	71.9	48.3
	388	35x35	26x26	0.68 - 0.90	1135-B3-0388-1B-00	71.9	48.3
	388	35x35	26x26	0.68 - 0.90	1135-B3-0388-1B-01	71.9	48.3
	388	35x35	26x26	0.68 - 0.90	1135-B3-0388-0A-00	71.9	48.3
	388	35x35	26x26	0.68 - 0.90	1135-B3-0388-0B-00	71.9	48.3
	388	35x35	26x26	0.68 - 0.90	1135-B3-0388-0B-01	71.9	48.3
	420	35x35	26x26	0.76 +/- 0.15	1135-B3-0420-0B-00	71.9	48.3
	436	35x35	26x26	0.68 - 0.90	1135-B3-0436-1B-00	71.9	48.3
	456	35x35	26x26	0.68 - 0.90	1135-B3-0456-0B-00	71.9	48.3
	456	35x35	26x26	0.76 +/- 0.14/0.16	1135-B3-0456-0A-00	71.9	48.3
	456	35x35	26x26	0.68 - 0.90	1135-B3-0456-0B-01	71.9	48.3
	456	35x35	26x26	0.68 - 0.90	1135-B3-0456-0B-02	71.9	48.3
	484	35x35	26x26	0.75	1135-B3-0484-0A-00	71.9	48.3
	492	35x35	26x26	0.68 - 0.90	1135-B3-0492-1B-00	71.9	48.3
	492	35x35	26x26	0.68 - 0.90	1135-B3-0492-0A-00	71.9	48.3
	492	35x35	26x26	0.68 - 0.90	1135-B3-0492-0A-01	71.9	48.3
	504	35x35	27x27	0.68 - 0.90	1135-B3-0504-1B-00	71.9	48.3
	528	35x35	26x26	0.68 - 0.90	1135-B3-0528-1B-00	71.9	48.3
	676	35x35	26x26	0.75 +/- 0.05	1135-B3-0676-1B-00	71.9	48.3
	728	35x35	27x27	0.75 +/- 0.15	1135-B3-0728-1B-00	71.9	48.3
	729	35x35	27x27	0.75 +/- 0.15	1135-B3-0729-1B-00	71.9	48.3
	352	35x35	26x26	0.68 - 0.90	1135-L3-0352-0A-00	94.0	65.3
	360	25x25	19x19	0.81 - 0.91	1125-B3-0360-0A-00	90.4	65.3
	400	37.5x37.5	29x29	0.75	1137-B3-0400-0A-10	94.0	65.3
	432	40x40	31x31	0.68 - 0.90	1140-B3-0432-0B-00	94.0	65.3
432	40x40	31x31	0.68 - 0.90	1140-B3-0432-0A-00	94.0	65.3	
432	40x40	31x31	0.68 - 0.90	1140-B3-0432-0A-01	94.0	65.3	
480	37.5x37.5	29x29	0.75	1137-B3-0480-1A-10	94.0	65.3	
480	37.5x37.5	29x29	0.75 +/- 0.1	1137-B3-0480-0A-10	94.0	65.3	
480	37.5x37.5	29x29	0.75	1137-B3-0480-0A-11	94.0	65.3	
481	37.5x37.5	27x27	0.76 +/- 0.15	1137-B3-0481-0A-10	90.4	65.3	
482	37.5x37.5	27x27	0.76 +/- 0.15	1137-B3-0482-0A-10	90.4	65.3	
503	37.5x37.5	27x27	0.68 - 0.90	1137-B3-0503-0A-10	94.0	65.3	
503	40x40	29x29	0.75	1140-B3-0503-0A-00	94.0	65.3	

Continued on next page



1100-3 Series 1.27mm Pitch Lidded BGA/LGA

Pitch e (mm)	Lead Count	Package Size	Matrix	Ball Dia. (mm)	Part Number	Socket Dimensions (mm)	
						Length (A)	Width (B)
1.27	504	40x40	29x29	0.68 - 0.90	1140-B3-0504-0A-00	94.0	65.3
	528	40x40	30x30	0.75	1140-B3-0528-0A-00	94.0	65.3
	551	40x40	29x29	0.68 - 0.90	1140-B3-0551-0A-00	94.0	65.3
	560	42.5x42.5	33x33	0.68 - 0.90	1142-B3-0560-1A-10	94.0	65.3
	560	42.5x42.5	33x33	0.68 - 0.90	1142-B3-0560-0A-10	94.0	65.3
	560	42.5x42.5	33x33	0.68 - 0.90	1142-B3-0560-1A-11	94.0	65.3
	560	42.5x42.5	33x33	0.68 - 0.90	1142-B3-0560-0A-11	94.0	65.3
	565	37.5x37.5	29x29	0.68 - 0.90	1137-B3-0565-1A-10	94.0	65.3
	569	40x40	31x31	0.75	1140-B3-0569-0A-00	94.0	65.3
	589	37.5x37.5	29x29	0.68 - 0.90	1137-B3-0589-1A-10	94.0	65.3
	596	40x40	30x30	0.68 - 0.90	1140-B3-0596-0A-00	94.0	65.3
	596	40x40	30x30	0.68 - 0.90	1140-B3-0596-0A-01	94.0	65.3
	596	40x40	30x30	0.68 - 0.90	1140-B3-0596-0A-02	94.0	65.3
	600	45x45	35x35	0.68 - 0.90	1145-B3-0600-0A-00	94.0	65.3
	600	42.5x42.5	31x31	0.68 - 0.90	1142-B3-0600-0A-10	94.0	65.3
	647	45x45	33x33	0.68 - 0.90	1145-B3-0647-0A-00	94.0	65.3
	652	45x45	35x35	0.75 +/- 0.14	1145-B3-0652-0A-00	94.0	65.3
	655	45x45	34x34	0.68 - 0.90	1145-B3-0655-0A-00	94.0	65.3
	656	40x40	30x30	0.75 +/- 0.15	1140-B3-0656-1B-00	90.4	65.3
	656	40x40	30x30	0.75 +/- 0.15	1140-B3-0656-1B-01	90.4	65.3
	672	45x45	34x34	0.75	1145-B3-0672-0A-00	94.0	65.3
	713	40x40	31x31	0.76 +/- 0.16	1140-B3-0713-0A-00	94.0	65.3
	713	45x45	34x34	0.75	1145-B3-0713-0A-00	94.0	65.3
	769	42.5x42.5	33x33	0.76	1142-B3-0769-0A-10	90.4	65.3
	838	37.5x37.5	29x29	0.68 - 0.90	1137-B3-0838-0A-10	90.4	65.3
	838	37.5x37.5	29x29	0.68 - 0.90	1137-B3-0838-0A-11	90.4	65.3
	838	37.5x37.5	29x29	0.68 - 0.90	1137-B3-0838-0A-12	90.4	65.3
	838	37.5x37.5	29x29	0.68 - 0.90	1137-B3-0838-0A-13	90.4	65.3
	841	37.5x37.5	29x29	0.68 - 0.90	1137-B3-0841-1A-10	90.4	65.3
	949	40x40	31x31	0.68 - 0.90	1140-B3-0949-0A-00	90.4	65.3
957	40x40	31x31	0.68 - 0.90	1140-B3-0957-0A-00	90.4	65.3	